



## **NEO Passive/Pasivas**



**User Manual / Manual de Uso**

Version 1.1

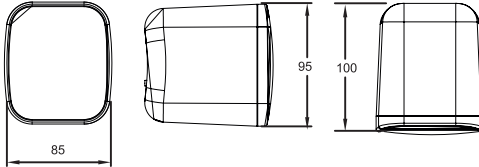
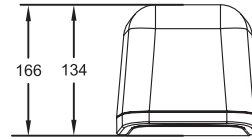
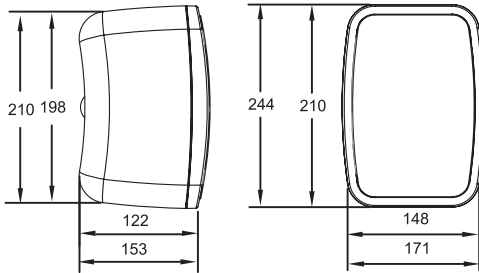
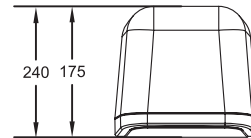
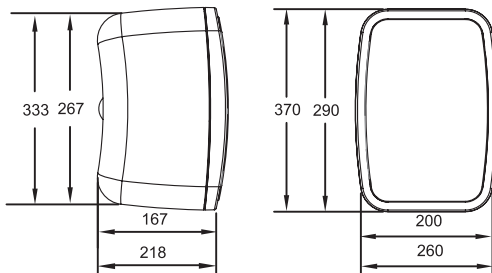
**NEO 3****NEO 4 NEO 5** (bigger)**NEO 6 NEO 8** (bigger)

A NEO 3/4/5/6/8 contains two loudspeakers (black or white) and two wall-mount brackets.

 The power tap is selected by rotating the slot of the 5 position rotary switch to the desired tap.



Make sure to select the correct power tap position before connecting the loudspeaker to a 70/100V line amplifier. If the low impedance position ( $8\Omega$ ) is selected, the loudspeaker could be damaged!

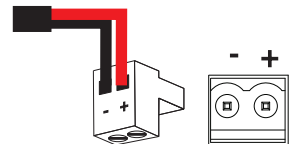

The connection is made through Euroblock terminals.  
Ensure the correct polarity is observed.

## NEO 3

(\*) Power Taps (70V).....  
 Power Taps (100V).....  
 Low Impedance position....  
 Sensitivity (1W/1m) .....  
 Max. SPL .....  
 Frequency Response .....  
 Elements.....

5W  
 10W  
 8Ω (50W)  
 87 dB  
 101 dB  
 120Hz - 20kHz  
 2.5" Woofer

Dimensions ..... 85 x 95 x 100 mm  
 Material (enclosure) . ABS plastic  
 IP rating ..... IP 54  
 RAL colour code ..... RAL 9003 (W)  
 / RAL 9004 (B)  
 Material (grille) ..... Aluminium  
 Weight ..... 0,5 Kg

## NEO 4

(\*) Power Taps (70V).....  
 Power Taps (100V).....  
 Low Impedance position....  
 Sensitivity (1W/1m) .....  
 Max. SPL .....  
 Frequency Response .....  
 Elements.....  
 Dimensions .....  
 Material (enclosure) .....  
 IP rating .....  
 RAL colour code .....  
 Material (grille) .....  
 Weight .....

1W/2W/4W/8W  
 2W/4W/8W/16W  
 8Ω (30W)  
 89 dB  
 104 dB  
 98Hz - 20kHz  
 4" Woofer + 0,5" Tweeter  
 148 x 210 x 134 mm

## NEO 5

1W/2W/4W/8W  
 2W/4W/8W/16W  
 8Ω (40W)  
 91 dB  
 107 dB  
 94Hz - 20kHz  
 5" Woofer + 0,5" Tweeter  
 171 x 244 x 166 mm

ABS plastic  
 IP 54  
 RAL 9003 (W) / RAL 9004 (B)  
 Aluminium  
 1,95 Kg      2,3 Kg

## NEO 6

(\*) Power Taps (70V).....  
 Power Taps (100V).....  
 Low Impedance position....  
 Sensitivity (1W/1m) .....  
 Max. SPL .....  
 Frequency Response .....  
 Elements.....  
 Dimensions .....  
 Material (enclosure) .....  
 IP rating .....  
 RAL colour code .....  
 Material (grille) .....  
 Weight .....

2W/4W/8W/16W  
 4W/8W/16W/32W  
 8Ω (60W)  
 92 dB  
 109 dB  
 80Hz - 20kHz  
 6.5" Woofer + 1" Tweeter  
 200 x 290 x 175 mm

## NEO 8

2W/4W/8W/16W  
 4W/8W/16W/32W  
 8Ω (70W)  
 93 dB  
 111 dB  
 86Hz - 16kHz  
 8" Woofer + 1" Tweeter  
 260 x 370 x 240 mm

ABS plastic  
 IP 54  
 RAL 9003 (W) / RAL 9004 (B)  
 Aluminium  
 3,1 Kg      4,95 Kg

(\*) The power taps indicated on the selector switch are calculated for 100V line. In the case of 70V line installation, each power tap will correspond to half the value.

Specifications are subject to change without notice

## IP54 weather proof rating

The NEO Passive/Pasivas is rated to IP54 which means there is limited dust and water ingress protection.

The NEO Passive/Pasivas is designed for both indoor and outdoor operation where it is protected from direct exposure to water (e.g. under a canopy). The use of protection from water and humidity for the connection terminals is highly recommended (e.g. sealant/mastic).

### Plastic Wall-mount bracket (NEO 4, NEO 5, NEO 6, NEO 8)

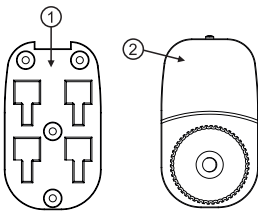

1	Rear wall mounting part
2	Allen Screw 45 mm x M6
3	M6 nut
4	Threaded Ball
5	M10 nut
6	Rear threaded insert (a)
7	Screw eyelet for safety cable (a) (b)

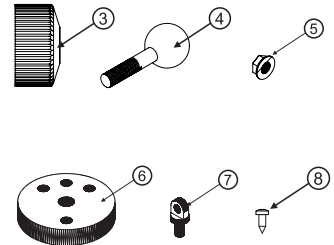

(a) Mounted to loudspeaker

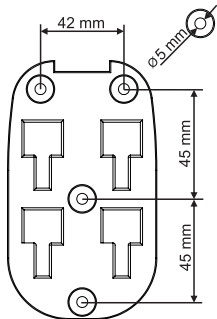

figure 1

### Mounting Process

Use the wall mounting part (1) to mark the fixing points on the wall. Take into account the dimensions between holes and the diameters marked in figure 1. Drill wall and insert wall fixings. Screw wall mounting part to wall. Ensure that suitable screws and wall fixings are used. If in any doubt contact a suitably qualified expert.

Mount (3), (4) & (5) as shown in figure 2. Screw the threaded ball (4) into the threaded insert on the rear of the loudspeaker (6) (loudspeaker not shown below). Tighten M10 nut (5) against the loudspeaker with a spanner. The assembly will now be as shown in figure 3.

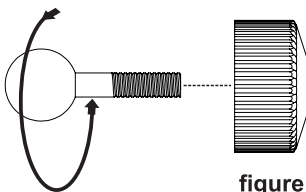

figure 2

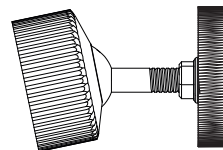

figure 3

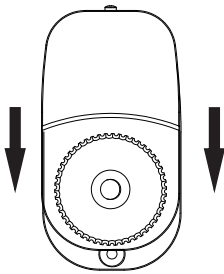
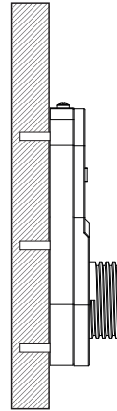
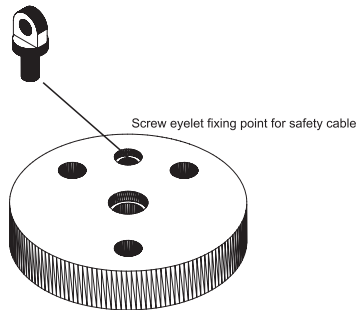
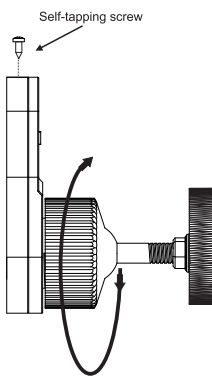

figure 4

Slide the hooks of the front threaded part (2) down in to the slots of the wall mount part (1). (figure 4)



Screw on the rotary knurled ring (3) several turns (do not tighten completely). Now adjust the loudspeaker to the desired position. Hold the speaker in position and tighten the knurled ring (3) completely. Use the self tapping screw (7) provided in order to lock parts (1) & (2) together.



**WARNING:** The maximum loading of this bracket (8 kg), must never be exceeded. No other items must be suspended or attached to the bracket or speaker enclosure.



## Plastic Wall-mount bracket (NEO 3)

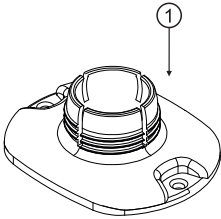

1	Rear wall mounting part
2	Threaded Ball
3	Locking nut
4	Fixation screw (x2)
5	Fixation nut

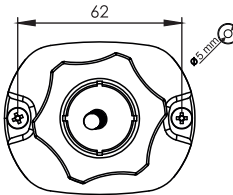
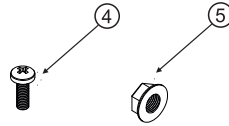
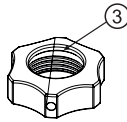
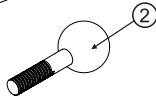

figure 1

Use the wall mounting part (1) to mark the fixing points on the wall. Take into account the dimensions between holes and the diameters marked in figure 1. Drill wall and insert wall fixings. Screw wall mounting part to wall. Ensure that suitable screws and wall fixings are used. If in any doubt contact a suitably qualified expert.

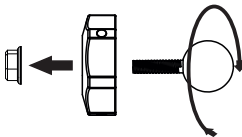

figure 2

Pass the threaded ball piece (2) through the locking nut (3) and screw it directly into the loudspeaker. Tighten M6 nut (5) against the loudspeaker with a spanner. Do not over tighten.

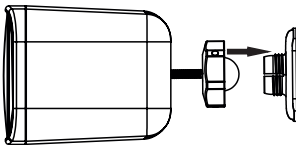

figure 3

Attach the complete set (loudspeaker+ threaded ball + locking nut) to the wall mounting part (1). See figure 3.

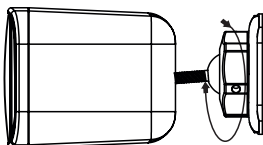
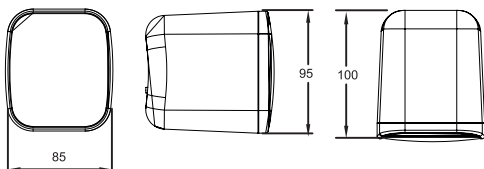
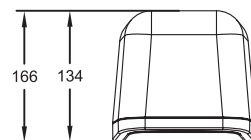
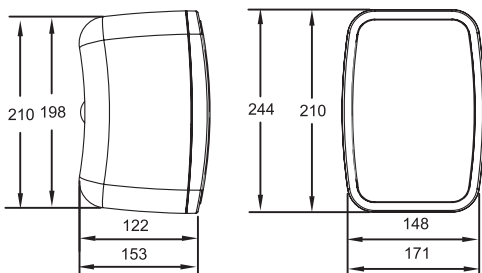

figure 4

Screw the locking nut (3) but not fully tight yet. See figure 4. Angle the loudspeaker to obtain the desired orientation. Once the angle is final, fully tighten the locking nut, but do not over tighten.



## NEO 3



## NEO 4 NEO 5 (mayor)

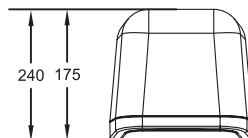
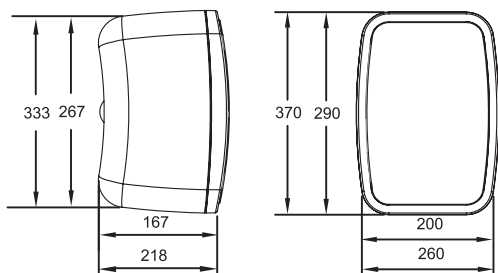

## NEO 6 NEO 8 (mayor)

**NEO 3/4/5/6/8** contiene dos altavoces (color blanco o negro) y 2 soportes de pared

La selección de potencia se realiza girando la ranura del conmutador rotativo de 5 posiciones hasta la posición deseada.



Asegúrese de seleccionar la correcta posición de potencia antes de conectar el altavoz a un amplificador de línea 70/100V. Si se selecciona la posición de baja impedancia (8Ω), el altavoz puede dañarse.

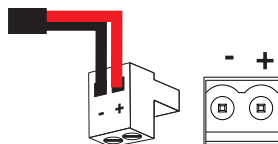

El conexionado se realiza mediante terminales Euroblock. Asegúrese de la correcta polaridad.

## NEO 3

(*) Potencia (70V).....	5W	Dimensiones .....	85 x 95 x 100 mm
Potencia (100V).....	10W	Material (recinto) .....	Plástico ABS
Potencia a baja impedancia...	8Ω (50W)	rango IP .....	IP 54
Sensibilidad (1W/1m) .....	87 dB	Código color RAL .....	RAL 9003 (W) / RAL 9004 (B)
Max. SPL .....	101 dB	Material (rejilla) .....	Aluminio
Respuesta en frecuencia .....	120Hz - 20kHz	Peso.....	0,5 Kg
Elementos.....	2.5" Woofer		

## NEO 4

(*) Potencia (70V).....	1W/2W/4W/8W
Potencia (100V).....	2W/4W/8W/16W
Potencia a baja impedancia...	8Ω (30W)
Sensibilidad (1W/1m) .....	89 dB
Max. SPL .....	104 dB
Respuesta en frecuencia .....	98Hz - 20kHz
Elementos.....	4" Woofer + 0,5" Tweeter
Dimensiones .....	148 x 210 x 134 mm
Material (recinto) .....	Plástico ABS
rango IP .....	IP 54
Código color RAL .....	RAL 9003 (W) / RAL 9004 (B)
Material (rejilla) .....	Aluminio
Peso.....	1,95 Kg

## NEO 5

(*) Potencia (70V).....	1W/2W/4W/8W
Potencia (100V).....	2W/4W/8W/16W
Potencia a baja impedancia...	8Ω (40W)
Sensibilidad (1W/1m) .....	91 dB
Max. SPL .....	107 dB
Respuesta en frecuencia .....	94Hz - 20kHz
Elementos.....	5" Woofer + 0,5" Tweeter
Dimensiones .....	171 x 244 x 166 mm
Material (recinto) .....	Plástico ABS
rango IP .....	IP 54
Código color RAL .....	RAL 9003 (W) / RAL 9004 (B)
Material (rejilla) .....	Aluminio
Peso.....	2,3 Kg

## NEO 6

(*) Potencia (70V).....	2W/4W/8W/16W
Potencia (100V).....	4W/8W/16W/32W
Potencia a baja impedancia...	8Ω (60W)
Sensibilidad (1W/1m) .....	92 dB
Max. SPL .....	109 dB
Respuesta en frecuencia .....	80Hz - 20kHz
Elementos.....	6.5" Woofer + 1" Tweeter
Dimensiones .....	200 x 290 x 175 mm
Material (recinto) .....	Plástico ABS
rango IP .....	IP 54
Código color RAL .....	RAL 9003 (W) / RAL 9004 (B)
Material (rejilla) .....	Aluminio
Peso.....	3,1 Kg

## NEO 8

(*) Potencia (70V).....	2W/4W/8W/16W
Potencia (100V).....	4W/8W/16W/32W
Potencia a baja impedancia...	8Ω (70W)
Sensibilidad (1W/1m) .....	93 dB
Max. SPL .....	111 dB
Respuesta en frecuencia .....	86Hz - 16kHz
Elementos.....	8" Woofer + 1" Tweeter
Dimensiones .....	260 x 370 x 240 mm
Material (recinto) .....	Plástico ABS
rango IP .....	IP 54
Código color RAL .....	RAL 9003 (W) / RAL 9004 (B)
Material (rejilla) .....	Aluminio
Peso.....	4,95 Kg

(\*) Las posiciones indicadas en el selector están calculadas para línea de 100V. En el caso de una instalación de línea 70V, cada posición de potencia corresponderá a la mitad del valor.

Las especificaciones están sujetas a cambio sin previo aviso.



## Rango de protección IP54

La serie NEO dispone de un rango de protección IP54 , el cual significa que tiene una protección limitada al ingreso de agua y polvo.

La serie NEO está diseñada tanto para instalaciones en interior como exterior donde está protegida de la exposición directa al agua (debajo de un dosel). Es muy recomendable el uso de protecciones contra el agua o la humedad en los terminales de conexión (p.e. sellándolos con silicona o masilla).

## Soporte de montaje en plástico (NEO 4, NEO 5, NEO 6, NEO 8)

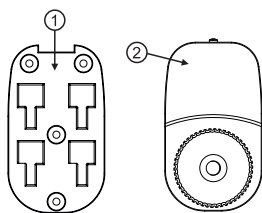

1	Pieza de montaje trasera pared
2	Tornillo Allen 45 mm x M6
3	Tuerca M6
4	Bola roscada
5	Tuerca M10
6	Pieza de inserción trasera (a)
7	Tornillo fijación cable de seguridad (a) (b)

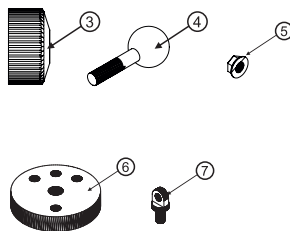

(a) Montado en el altavoz



figura 1

## Proceso de Montaje

Use la pieza de montaje (1) para marcar los puntos de fijación a la pared. Tenga en cuenta las medidas y diámetros marcados en la figura 1.

Fije la pieza a la pared. Asegúrese de fijarlo con todos los tornillos. Si tiene cualquier duda, consulte con un técnico.

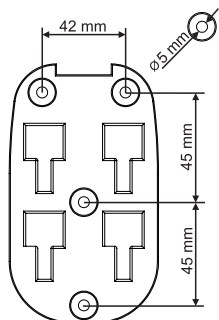
Monte las piezas (3), (4) y (5) como muestra la figura 2. Atornille la pieza (4) dentro de la inserción roscada del altavoz (6). Fije la tuerca M10 (5) contra el altavoz. El montaje se muestra en la figura 3 3.



figura 2



figura 3

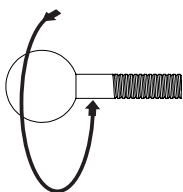

figura 4

Deslice la pieza frontal sobre la pieza montada en la pared (figura 4)



Atornille el aro rotativo (3) varias veces (sin fijarlo totalmente).  
 Ahora ajuste el altavoz en la posición deseada.  
 Fije el altavoz y apriete el aro (3) completamente.  
 Use el tornillo de fijación del cable (7).

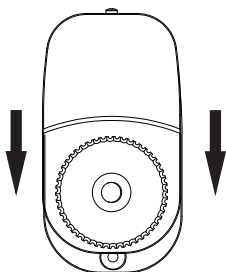
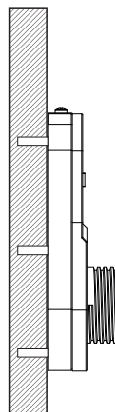
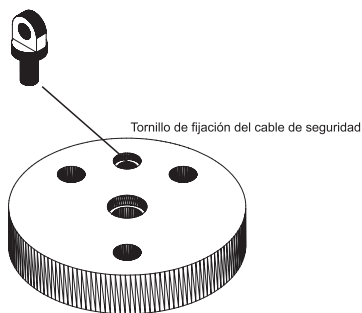
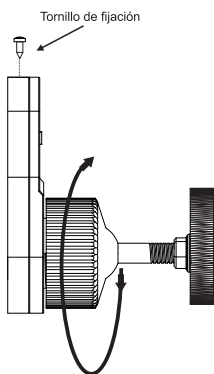

**ATENCIÓN:** La carga máxima soportada por ester soporte (8 kg), no debe sobrepasarse.  
 No se debe utilizar para la fijación de un elemento distinto de estos modelos de altavoz.



## Soporte plástico de fijación a pared (NEO 3)

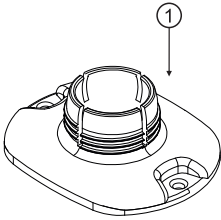

1	Pieza de montaje a pared
2	Bola roscada
3	Tuerca de fijación
4	Tornillo de fijación (x2)
5	Tuerca de fijación

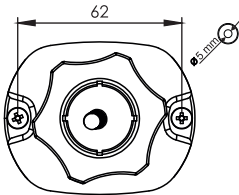
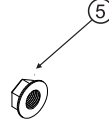
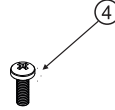
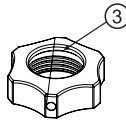
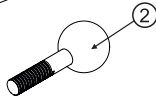

Use la pieza de montaje (1) para marcar los puntos de fijación a la pared. Tenga en cuenta las medidas y diámetros marcados en la figura 1.

Fije la pieza a la pared. Asegúrese de fijarlo con todos los tornillos. Si tiene cualquier duda, consulte con un técnico.

figura 1



figura 2

Pase la pieza roscada (2) a través de la tuerca de bloqueo (3) y atornille directamente al altavoz.

Apriete la tuerca M6 (6) al altavoz. No la apriete completamente.

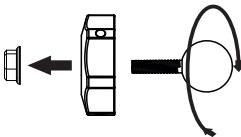

figura 3

Junte todo el set (altavoz+bola roscada+tuerca de bloqueo) a la pieza montada en la pared (1).

Ver figura 3

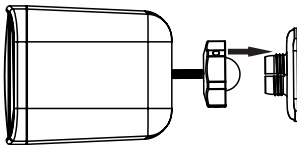

figura 4

Atornille la tuerca de bloqueo (3) pero no del todo.

Ver figura 4. Angule el altavoz para obtener la orientación deseada. Una vez hecho esto, apriete la tuerca completamente.

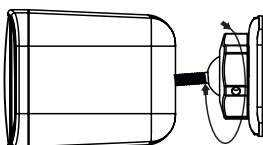

This symbol on the product or on its packaging indicates that this product shall not be treated as household waste. Instead it shall be handed over to the applicable collection point for the recycling of electrical and electronic equipment. By ensuring this product is disposed of correctly, you will help prevent potential negative consequences for the environment and human health, which could otherwise be caused by inappropriate waste handling of this product. The recycling of materials will help to conserve natural resources. For more detailed information about recycling of this product, please contact your local city office, your household waste disposal service or the shop where you purchased the product.

Manufactured by **EQUIPSON, S.A.**

<http://www.equipson.es>