

Instruction Manual

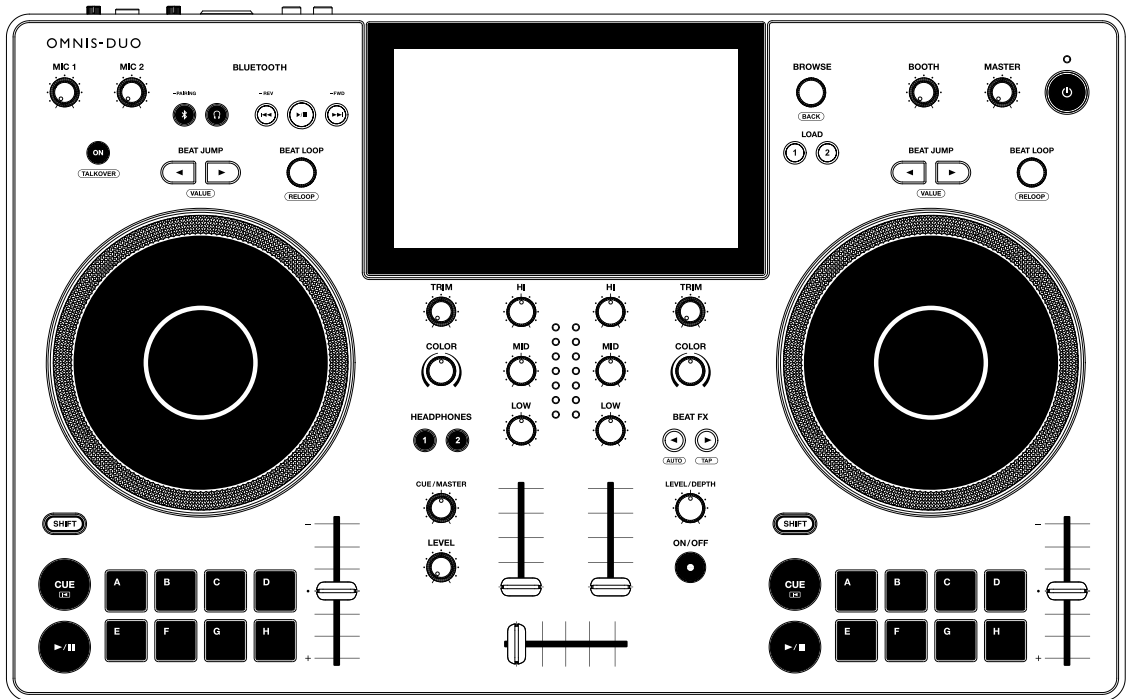

All-In-One DJ System

OMNIS-DUO

alphatheta.com/support/

rekordbox.com

For FAQ and other support information for this product, visit the websites above.

Contents

Before you start	7
How to read this manual	7
What's in the box.....	7
User guides	8
Safety precautions	8
Disposal of the unit.....	10
Product overview	11
Charging the battery.....	11
System requirements	13
rekordbox for Mac/Windows.....	16
rekordbox for iOS/Android.....	18
PRO DJ LINK	19
rekordbox CloudDirectPlay	19
PC/Mac setup	20
Setting Utility	22
Part names	25
Top panel	25
Front panel	27
Rear panel.....	27
Touch screen	29
Connections (basic styles)	38
PRO DJ LINK	38
rekordbox CloudDirectPlay	40
Storage device connection (SD, USB)	41
SD memory card	41
USB storage device	42

Track selection	43
Browse section	43
Selecting a source.....	43
Selecting a track.....	44
Searching for a track	44
Monitoring sound before loading a track (Touch Preview).....	47
Loading a track to a deck	48
Using History	49
Using the Tag List	50
Displaying the playlist screen	53
Playback	55
Deck section.....	55
Play/pause	56
Playing a track from the touched point on the overall waveform.....	56
Slip mode	57
Adjusting the playback speed (tempo control)	57
Adjusting the playback speed without changing the pitch (Master Tempo)...	58
Recording	59
Splitting a track during recording.....	60
Using the jog wheel	61
Setting the jog wheel mode.....	61
Jog wheel operations	62
Adjusting the playback starting and stopping speeds (for Vinyl mode)	63
Cueing	64
Setting a cue point	64
Jumping to a cue point	64
Checking a cue point (Cue Point Sampler)	65
Saving a cue point.....	65
Calling up a saved cue point	66

Deleting a saved cue point.....	66
Setting Auto Cue	67
Looping.....	68
Setting a loop	68
Adjusting the length of a loop.....	68
Using Active Loop	69
Canceling loop playback	69
Emergency Loop	69
Saving a loop	70
Calling up a saved loop.....	70
Deleting a saved loop.....	71
Hot Cues	72
Setting a Hot Cue	72
Starting playback from a Hot Cue point	73
Registering or deleting a Hot Cue	73
Beat Jump/Loop Move	74
Beat section	74
Using Beat Jump/Loop Move	74
Quantize (for deck).....	75
Using Quantize.....	75
Beat Sync	76
Using Beat Sync.....	76
Using Instant Doubles	77
Beatgrid	78
Adjusting the beatgrid	78
Cloud.....	79
rekordbox CloudDirectPlay	79
Audio output	87
Channel section/master section	87

Outputting sound	88
Adjusting the sound	89
Setting the faders	89
Monitoring sound	91
Headphones section	91
Monitoring with headphones	92
Booth section	93
Using a booth monitor	93
Microphone	94
MIC section	94
Using a microphone	95
Sound Color FX.....	96
Sound Color FX section	96
Using Sound Color FX	97
Sound Color FX types and settings.....	98
Beat FX	100
Beat FX section.....	100
Using Beat FX.....	101
Setting BPM manually (Tap mode)	102
Using Quantize (for Beat FX)	103
Beat FX types and settings	104
Settings.....	106
Changing the settings from the SETTINGS screen	106
Changing the settings from the UTILITY screen	108
Changing the settings from the PORTABILITY screen	113
Calling up My Settings saved on a storage device (SD, USB).....	115
Bluetooth^{®/MD} connection	116
Bluetooth input section.....	116
Pairing with a Bluetooth device (Bluetooth input).....	117

DJing with the sound from a mobile device, etc. (Bluetooth Playback) ...	119
Connecting to a mobile speaker, etc. (Bluetooth output)	120
Wireless LAN (Wi-Fi®) connection.....	122
Checking the internet connection.....	123
Using DJ software	124
Controlling DJ software	124
Specifications	126
Additional information	129
Troubleshooting	129
LCD display	131
Battery	132
Trademarks and registered trademarks	133
Cautions on copyrights.....	134

Before you start

How to read this manual

- Thank you for choosing this AlphaTheta product.
Be sure to read this manual, the Quick Start Guide and the Precautions for Use which are also included with this product. These documents include important information that you should understand before using the unit.
- In this manual the names of buttons, knobs and terminals that appear on the product, and the names of buttons, menus etc. in the software on your PC/Mac or mobile device, are indicated within square brackets ([]). (e.g. **[File]**, **[CUE]** button)
- Please note that the software screens and their specifications, as well as the external appearance and specifications of the hardware, are subject to change without notice.
- Please note that depending on the operating system version, web browser settings, etc. operation may differ from the ways described in this manual.
- Please note that the language on the screens of the software described in this manual may differ from the language on your screen.

What's in the box

- AC adapter
- Power cord
- Warranty (for some regions)^{*1}
- Quick Start Guide
- Precautions for Use

*1 Only products in Europe.

Products in North America and Japan include warranty information in the Precautions for Use.

User guides

❖ rekordbox Introduction, Instruction Manual

Refer to the rekordbox Introduction to find out how to set up rekordbox, and see the Instruction Manual to find out how to use rekordbox.

Visit the URL below to find these user guides.

rekordbox.com/manual

Safety precautions



Danger



Failure to observe the following precautions may result in burns or serious injury due to fire, electric shock, overheating, or ignition.



Prohibited

Do not put the unit into fire. Do not apply strong impacts or pressure to the unit, or mechanically crush or cut the battery.

There is a risk of rupture or leakage of the built-in rechargeable battery, which may result in injury or burns.



Do not disassemble.

Doing so may cause a malfunction or the built-in rechargeable battery to leak or rupture.

For internal inspection and repair, consult an authorized service company or your dealer.



Prohibited

Do not use, store, or leave the unit in hot places such as near fire, in direct sunlight, or in a hot car.

Leakage, rupture, or overheating of the built-in rechargeable battery may cause fire, injury, or contamination of surroundings. If the battery leaks or gives off a strange odor, immediately keep the unit away from fire.



Prohibited

Do not put the unit in a place with oily smoke, humidity, and/or dust, such as near a cooking table or humidifier.

Doing so may cause fire or electric shock.

If battery fluid leaks, do not touch it with bare hands.

The leaked battery fluid may remain inside the unit. Consult an authorized service company or your dealer.



Danger

If the battery fluid gets into your eyes, it may lead to blindness. Do not rub your eyes. Immediately wash your eyes off with clean water and consult a doctor.

If the battery fluid gets on your body or clothes, it may cause burns or injuries. Immediately wash it off with clean water and consult a doctor if you have any symptoms of inflammation or injury on your skin.



Warning



Fire



Electric shock

Failure to observe the following precautions may result in burns or serious injury due to fire, electric shock, overheating, or ignition.



Observe

Always use the supplied AC adapter and power cord with the unit.

If the unit is used with a power cord and/or an AC adapter from other products, it may not exert its full performance and/or heat generated due to insufficient current may cause fire or electric shock.



Prohibited

Do not damage the power cord and/or AC adapter.

- Do not put the power cord and/or AC adapter near any heat sources such as stoves or other apparatus that produce heat.
- Do not place heavy objects on the power cord and/or AC adapter or place the unit on them.
- Do not pull, twist, or forcibly bend the power cord.
Doing so may damage the cord and cause fire or electric shock.

Disposal of the unit

Depending on the usage, usage environment, storage conditions, etc., the battery may leak, rupture, overheat, or catch fire, which may cause injury or device failure. Be sure to follow the precautions on the Precautions for Use. This unit contains the following battery.

- Dedicated rechargeable lithium ion battery

When disposing of this product, comply with governmental regulations or environmental public institution's rules that apply in your country/area. By disposing of it correctly, you'll help to save valuable resources.

Product overview

You can use this unit with the supplied AC adapter (power cord) connected to a power outlet, or the built-in lithium-ion battery.

When you use the unit for the first time, connect the supplied AC adapter (power cord) to a power outlet and charge the battery at least partially (or the unit won't turn on).

Charging the battery

Use the supplied AC adapter (power cord) to charge the battery.

- The recommended charging temperature is 10 to 35°C (50 to 95°F). When temperature is outside of the recommended charging temperature, a charging not possible icon will be displayed on the status display (page 29).
- Never use the AC adapter if its USB cable connector (terminal) is bent or broken.
- Do not charge the battery in a place where it may be splashed with liquid.
- Be careful not to allow liquids (sweat or drinking water) or foreign substances (dirt, dust, metal pieces, etc.) to adhere to the connector (terminal) of the USB cable.
- Make sure no load is put on the cable and connector of the AC adapter. Place the unit and the adapter at the same level.

1 Connect the USB cable connector of the AC adapter to the USB port (for power input) on the rear of the unit.

Rear panel of the unit

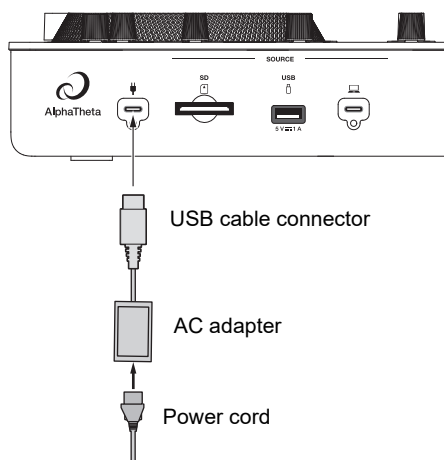

- Insert the USB cable connector straight into the USB port.

2 Connect the power cord to a power outlet.

The battery charge indicator lights up in orange.

Top panel of the unit Battery charge indicator

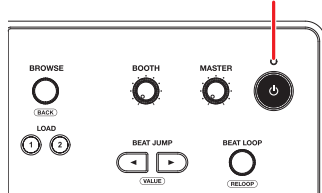

- The battery charge indicator lights up in orange while charging and turns off when charging completes.
- The battery charge indicator may flicker immediately after starting charging. It will light up normally after charging for a while.
- If the battery level is low, you may not be able to turn the unit on. After charging the battery for a while, turn it on.
- It takes approximately 3 hours to fully charge the battery from empty.

System requirements

Supported audio sources

This unit supports the following sources.

- SD memory card*
- USB storage device
- PC/Mac (rekordbox for Mac/Windows)
- Mobile device (rekordbox for iOS/Android)

* SD memory cards, and miniSD memory cards and microSD memory cards (use them with an SD memory card adapter) are collectively referred to as “SD memory card” in this manual.

Use storage devices (SD, USB) that support the following specifications.

Folder hierarchy	Up to 8 levels (Files in the lower levels can't be played with the unit.)
Maximum number of folders	Unlimited (Up to 10 000 folders in a folder can be displayed.)
Maximum number of files	Unlimited (Up to 10 000 files in a folder can be displayed.)
File format	FAT16, FAT32, exFAT, HFS+ (NTFS isn't supported.)

- It may take some time for the unit to read a device when it contains many folders and files.
- Storage devices (SD, USB) may not work properly if there isn't enough free space.
- Some storage devices (SD, USB) may not work properly with this unit.
- We accept no responsibility for loss of data from a storage device (SD, USB), or other direct or indirect problems resulting from connections to this unit.

❖ SD memory cards

- The unit can play audio files saved on SD memory cards that conform to SD/SDHC/SDXC standards.
- CPRM isn't supported.

❖ USB storage devices

- The unit can play audio files saved on USB mass storage class devices.
- The unit doesn't support the following.

- Optical disc devices such as external DVD/CD drives
- USB hubs
- If excessive current passes through the USB port on the unit, the unit stops the power supply to the USB storage device and stops communication. To restore the unit to a normal condition, disconnect the USB storage device from the unit. Do not use the USB storage device with the unit again.
If you still can't restore the unit to a normal condition (i.e. if the unit doesn't communicate with a connected USB storage device), turn the unit off and on.
- If USB storage devices have multiple partitions, only the first partition can be used (or if there is a partition including rekordbox library, the partition is used instead).
- USB storage devices with a flash card reader may not work properly with this unit.

Supported file formats

The unit supports audio files in the following formats.

Type	Extension	Format	Bit depth	Bit rate	Sampling frequency
MP3	.mp3	MPEG-1 AUDIO LAYER-3		32 to 320 kbps	
AAC	.m4a, .aac, .mp4	MPEG-4 AAC LC MPEG-2 AAC LC	16bit	16 to 320 kbps	44.1 kHz, 48 kHz
WAV	.wav	WAV			
AIFF	.aif, .aiff	AIFF			
Apple Lossless	.m4a	ALAC	16bit, 24bit	—	44.1 kHz, 48 kHz
FLAC	.flac, .fla	FLAC			

- Some files can't be played with the unit even if they are in a supported format.

Tag information

This unit can read tag information from ID3 tags (v1, v1.1, v2.2.0, v2.3.0, v2.4.0) and meta tags set in audio files.

Artwork of audio files

You can add an artwork image in JPEG format (extensions: “jpg”, “jpeg”) to each audio file. Images larger than 800 x 800 pixels can't be displayed on this unit.

Display language

If you want to display characters (track names, etc.) in local codes other than Unicode, change the [**Language**] setting (page 111).

rekordbox for Mac/Windows

rekordbox for Mac/Windows is a complete DJ application for PC/Mac that you can use to manage your music and perform.

- If you export audio files managed in Export mode of rekordbox for Mac/Windows to a storage device (SD, USB) and connect the storage device to this unit, you can DJ with the audio files in the storage device.

If you connect a PC/Mac to the unit via PRO DJ LINK, you can directly load audio files from the PC/Mac to the unit (page 38).

- This unit is a Hardware Unlock device. If you connect a PC/Mac running rekordbox for Mac/Windows to the unit, you can use Performance mode (rekordbox DJ functions) for free.
- For information on functions supported by Hardware Unlock, visit the URL below.
rekordbox.com
- rekordbox for Mac/Windows isn't included with the unit. Download the software from the URL below.
rekordbox.com
- For information on the latest system requirements, compatibility, and supported operating systems for rekordbox for Mac/Windows, visit the URL below.
rekordbox.com/system
- Operation isn't guaranteed on all PC/Mac models, even if the system requirements are met.
- Depending on power-saving settings and other conditions of your PC/Mac, the CPU and hard disk may not provide sufficient processing capabilities. For laptops in particular, make sure the PC/Mac is in the best condition to provide constant high-level performance when using rekordbox for Mac/Windows (for example by keeping the AC power connected).

Device Library Plus

This unit only supports the Device Library Plus format.

Perform the following procedure before you use a storage device (SD, USB) which has the library exported from rekordbox for Mac/Windows with this unit. Once you have performed the following procedure, you can use the storage device (SD, USB) as usual.

- Perform the following procedure even if you exported audio files using the previous version of rekordbox for Mac/Windows.

1 Update to the latest version of rekordbox for Mac/Windows.

rekordbox.com

2 Launch rekordbox for Mac/Windows.

3 Connect a storage device (SD, USB) to your PC/Mac.

4 If a conversion message appears, click [OK].

Conversion starts.

After conversion completes, you can use the storage device (SD, USB).

- For information on Device Library Plus, refer to the FAQ at the URL below.

rekordbox.com/support/faq

rekordbox for iOS/Android

rekordbox for iOS/Android is a complete DJ application for mobile devices (iOS/iPadOS/Android) that you can use to manage your music and perform.

If you connect a mobile device running rekordbox for iOS/Android to the unit, you can play audio files managed in the app.

- The DJ performance functions in rekordbox for iOS/Android ver. 4.0.0 or later can't be used with this unit.
- Connect your mobile device to the same Wi-Fi network as this unit (page 122).
- Turn your mobile device to the portrait orientation, select [**Connect to CDJ/XDJ/DJM**] on the screen shown below, and start the PRO DJ LINK connection.
- After the PRO DJ LINK connection is established, you'll be able to load and play audio files from your mobile device to the unit.

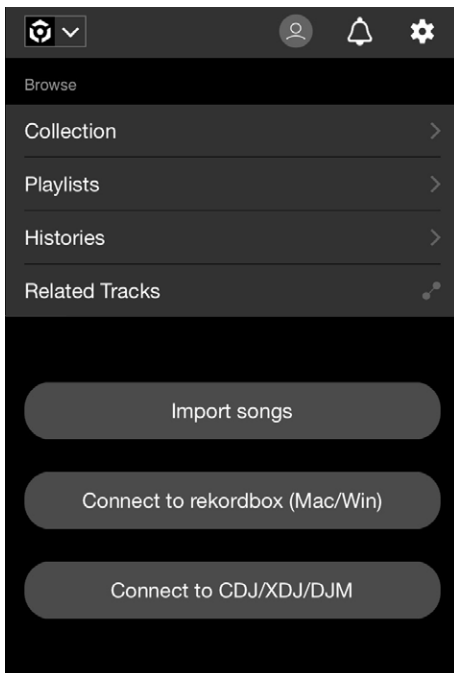

- For information on connecting the unit with rekordbox for iOS/Android, refer to the FAQ at the URL below.

iOS/iPadOS:

rekordbox.com/en/support/faq/connecting-to-dj-units/#faq-q100037

Android:

rekordbox.com/en/support/faq/connecting-to-dj-units-android/#faq-q110039

PRO DJ LINK

PRO DJ LINK supports SD & USB Export, which utilizes a storage device (SD, USB), as well as rekordbox LINK EXPORT, which utilizes a PC/Mac or mobile device running rekordbox.

➡ Read more: PRO DJ LINK (page 38)

rekordbox CloudDirectPlay

If you connect the unit to the internet via a wireless LAN (Wi-Fi) and use rekordbox CloudDirectPlay, you can load audio files from your cloud storage to the unit and play them.

➡ Read more: Cloud (page 79)

PC/Mac setup

To input or output your PC's (Windows) audio to/from the unit, install the dedicated audio driver software on your computer. You don't need to install this driver if you use a Mac.

- Audio driver software: Driver software used for outputting the PC audio when using the unit with DJ software. If you install the audio driver software to your PC, Setting Utility will also be installed with the driver software (page 21).
- For information on the latest system requirements, compatibility, and supported operating systems, visit the URL below.

alphatheta.com/support/

- Operation isn't guaranteed on all PC models, even if the system requirements are met.
- Operation isn't guaranteed when multiple units are connected to a PC/Mac.
- If a PC without the dedicated audio driver software installed is connected to the unit, errors may occur on the PC.
- Malfunctions may occur due to incompatibility with other software installed on a PC/Mac.

Installation

❖ Notes on installation

- Turn the unit off and disconnect the USB cable connected to the unit and the PC (Windows) before installation.
- Close all applications running on the PC before installation.
- You'll need admin rights to install the dedicated audio driver software to your PC.
- Read the License Agreement terms carefully before installation.
- If you quit the installation halfway through, perform the installation procedure from the beginning again.
- After the installation is complete, connect the PC to the unit.
- Operation isn't guaranteed on all PC models.

Downloading the dedicated software

1 Visit the URL below.

alphatheta.com/support/

2 Click [Software & firmware updates].

3 Click [OMNIS-DUO] under [All-in-one DJ systems].

4 Click [Drivers].

5 Click [Download link] and save the file.

- Download the audio driver software dedicated to your PC.

Installing the dedicated software

1 Unzip the downloaded dedicated software.

- Unzip “OMNIS-DUO#####exe.zip” (# indicates the version number of the software).

2 Double-click the installation file.

- Double-click “OMNIS-DUO_#.###.exe” (# indicates the version number of the software).

3 Read the Software end user license agreement carefully. If you agree to the terms, mark the [Agree] check box and click [OK].

- If you don't agree to the license agreement terms, click [**Cancel**] to cancel the installation.

4 Follow the on-screen instructions to complete the installation.

Setting Utility

Once you've installed the driver software on your PC, you can use the Setting Utility for the following.

- Adjusting the buffer size (for Windows ASIO) (page 23)
- Checking the software version (page 24)

Launching Setting Utility

❖ For Windows 11

- 1 Open the Start menu and click [All Apps] → [AlphaTheta] → [OMNIS-DUO Setting Utility].

❖ For Windows 10

- 1 Open the Start menu and click [AlphaTheta] → [OMNIS-DUO Setting Utility].

Adjusting the buffer size (for Windows ASIO)

- Close any running applications (DJ applications, etc.) which use the unit as the default audio device before adjusting the buffer size.

1 Click the [ASIO] tab.

2 Adjust the buffer size with the slider.

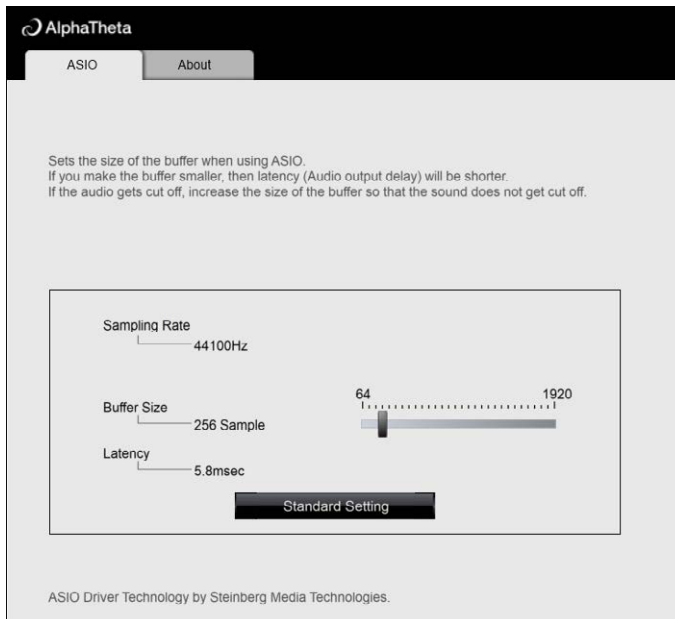

- Breaks in sound are less likely to occur if you set a large buffer size, but this increases lag time due to the latency of audio data transmission.

Checking the software version

1 Click the [About] tab.



Part names

Top panel

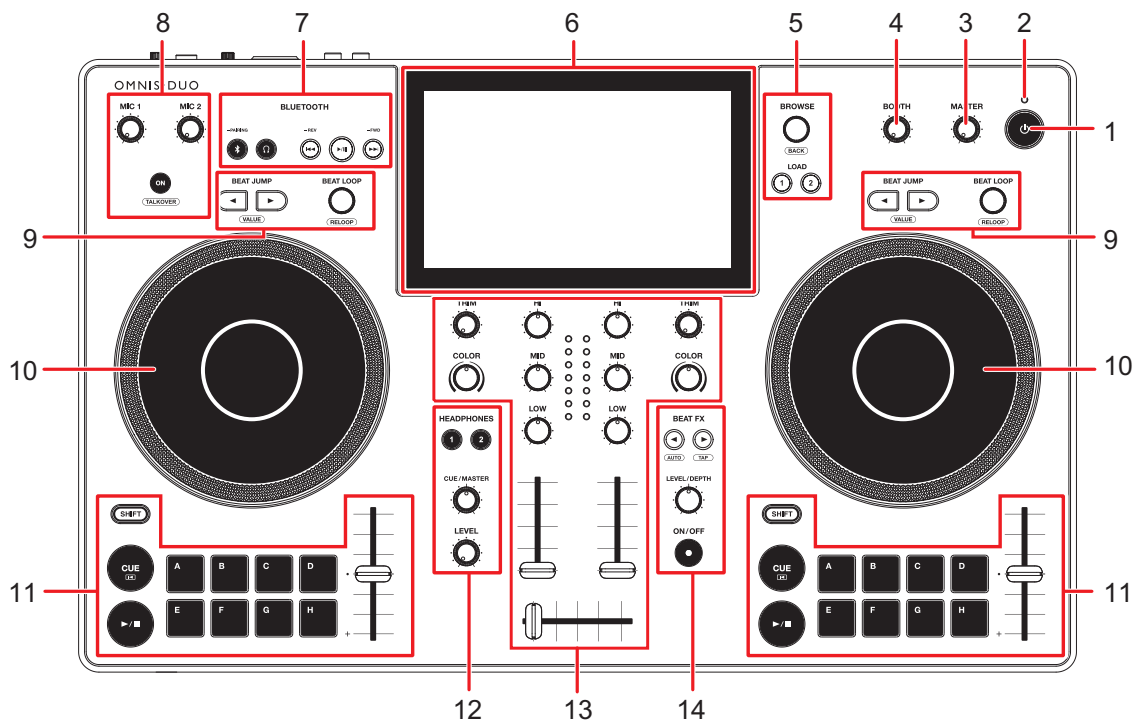

1. button

Press and hold to turn the unit on or press to turn it off.

- The confirmation message appears on the display before the unit turns off.
- When you use the unit for the first time or after not using it for a long time, connect the AC adapter (power cord) to a power outlet and charge the battery at least partially.
- If you turn the unit on when the battery level is too low, the  button blinks red for 10 seconds and the unit doesn't turn on.

2. **Battery charging indicator**

Lights up when charging the battery, and turns off when charging completes.

- The battery level is displayed on the touch screen.

 **CAUTION**

- When using the unit on battery power without using the AC adapter (power cord), pay attention to the battery level. If the battery runs out, the contents in the memory are cleared. Connect the AC adapter (power cord) and charge the battery before it runs out.

3. **MASTER LEVEL knob** (page 87)
4. **BOOTH LEVEL knob** (page 93)
5. **Browse section** (page 43)
6. **Touch screen** (page 29)
7. **Bluetooth input section** (page 116)
8. **MIC section** (page 94)
9. **Beat section** (page 74)
10. **Jog wheel** (page 62)
A sensor is built into the top of the jog wheel. Do not place anything on it or apply strong force to it.
11. **Deck section** (page 55)
12. **Headphones section** (page 91)
13. **Channel/master section** (page 87)
14. **Beat FX section** (page 100)

Front panel

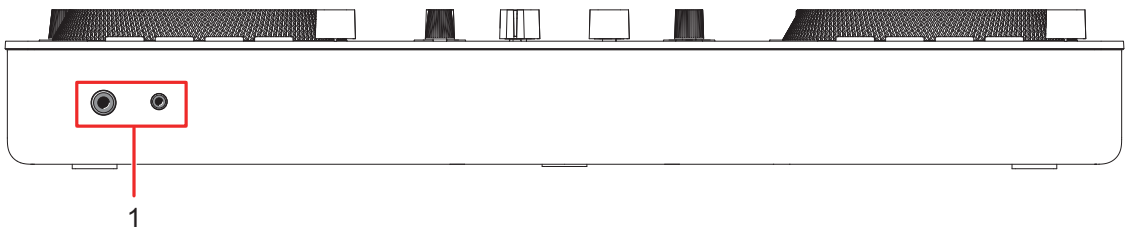

1. PHONES terminals (page 92)

Connect headphones to one of the terminals (1/4" stereo jack or 3.5 mm stereo mini-jack). If you use both terminals at the same time, the sound quality may be deteriorated or the volume may be low.

Rear panel

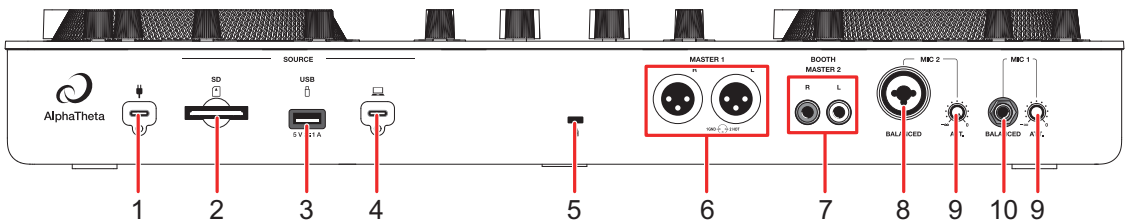

1. USB port (for power supply) (page 11)

Connect to a power outlet with the supplied AC adapter (power cord).

CAUTION

- Never use the AC adapter if its USB cable connector (terminal) is bent or broken.
- Insert the USB cable connector straight into the USB port.
- Be careful not to allow liquids (sweat or water) or foreign substances (dirt, dust, metal pieces, etc.) to adhere to the connector (terminal) of the USB cable.
- Make sure no load is put on the cable and connector of the AC adapter. Place the unit and the adapter at the same level.

2. SD memory card slot (page 41)

3. USB port (for USB storage device) (page 42)

4. **USB port (for PC/Mac)** (page 39)

Connect a PC/Mac. Use a 2 m or shorter standard USB cable.

5. **Kensington security slot**

Connect a cable lock.

6. **MASTER 1 terminals (balanced XLR)**

Connect to analog input terminals on a power amplifier, etc.

- Use the terminals for balanced output only. Connecting the terminals to unbalanced inputs (RCA, etc.) with an XLR-RCA conversion cable (conversion adapter), etc. results in unwanted noises and/or poor sound quality.
- Do not connect a power cord from another product to the terminals.
- Do not connect to a terminal that can supply phantom power.
- Use the [**BOOTH/MASTER 2**] terminals for unbalanced input (RCA, etc.).

7. **BOOTH/MASTER 2 terminals (RCA)**

Connect to analog input terminals on a power amplifier, etc.

8. **MIC 2 terminal (XLR or 1/4"/6.35 mm, TRS)** (page 95)

9. **ATT. knob** (page 95)

10. **MIC 1 terminal (TRS)** (page 95)

Touch screen

Title/status bar

The title/status bar is displayed at the top of the screen.



1. **☰ (Launcher)**
Displays the launcher screen.
Closes the display when **X** is displayed.
2. **< (BACK)**
Returns to the previous screen.
3. **Screen title**
Displays the title of the current screen.
 - If **[WAVEFORM]** is displayed instead of the current screen title, touch it to display the **[WAVEFORM]** screen.
4. **i (INFO)**
Displays or hides the information of the selected track.
5. **T (TRACK FILTER/EDIT)**
Searches for tracks using Track Filter (page 46).
6. **Q (SEARCH)**
Displays the Search screen (page 44).
7. **REC**
Displays the recording (Master Rec) panel (page 59).
8. **Master level indicator** (page 89)
9. **Status display**
Displays the following statuses.
 - Bluetooth connection status (📶: Bluetooth on/connected, ✖️: Bluetooth off)
 - Wi-Fi connection status (📶, 📶, 📶, 📶: Wi-Fi on/signal strength, ✖️: Wi-Fi off)
 - Battery level and charging status (🔋: Battery level, 🔌: Charging, 🔌🔋: Charging not possible)
 Touch to display the **[PORTABILITY]** screen (page 113).

Launcher screen

The launcher screen appears when you touch  on the title/status bar at the top of the screen. You can open various screens from the launcher screen.

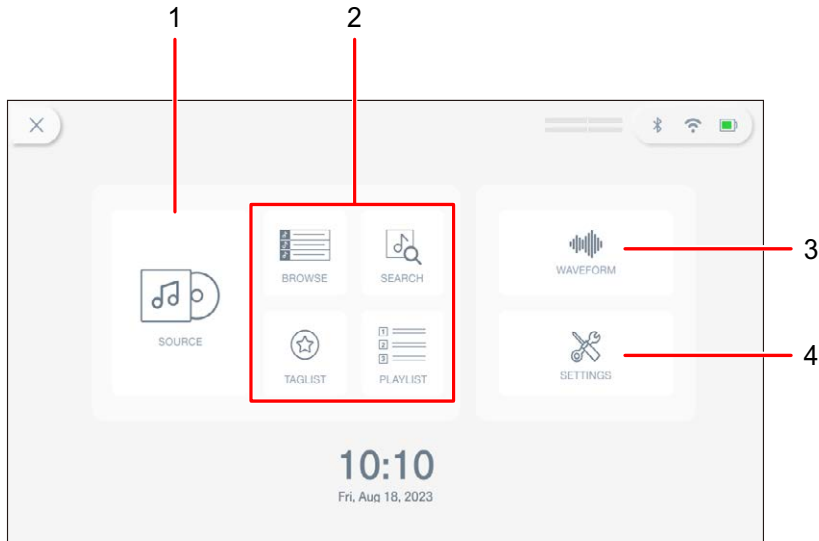

1. **SOURCE**

Displays the [**SOURCE**] screen (select a source to play a track from) (page 31).

2. **Browse buttons**

Displays the browse screen when you touch [**BROWSE**], [**TAGLIST**], or [**PLAYLIST**] (page 32), or the Search screen when you touch [**SEARCH**] (page 44).

3. **WAVEFORM**

Displays the [**WAVEFORM**] screen where you can play a loaded track (page 33).

4. **SETTINGS**

Displays the [**SETTINGS**] screen where you can specify various settings (page 106).

Source screen

The **[SOURCE]** screen appears when you touch **[SOURCE]** on the launcher screen.



1. Source icons

Displays the icon of the connected source.

2. Source name/status

Displays the source name and status.

3. Source information

Displays the information of the selected source.

- The following function is available when a storage device (SD, USB) is selected.
 - **[MY SETTINGS LOAD]**: Calls up the Utility and other settings saved in the selected storage device (SD, USB).
- The following function is available when a Bluetooth device is selected.
 - **[Send to]**: When it's set to **[DECK]**, you can DJ with the sound input from the connected Bluetooth device (page 119). When it's set to **[MIXER]**, the audio is input from the connected Bluetooth device.

Browse screen

Touch **[BROWSE]**, **[TAGLIST]**, **[PLAYLIST]** on the launcher screen to display the browse screen (track list).

You can browse the rekordbox library on a storage device (SD, USB), rekordbox CloudDirectPlay, a connected PC/Mac (rekordbox for Mac/Windows), or a mobile device (rekordbox for iOS/Android).

- If you browse a storage device (SD, USB) that doesn't contain a rekordbox library on the **BROWSE** screen, the folder and track lists are displayed in a hierarchical structure.

Example: when you touch **[BROWSE]**

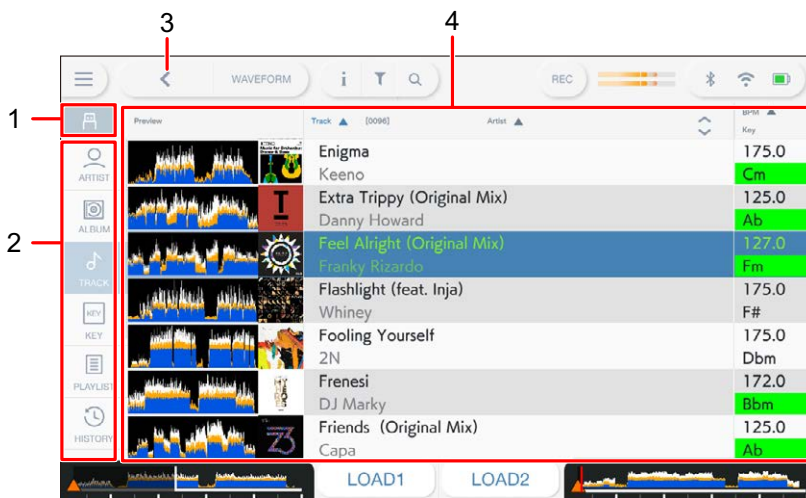

1. **Source icon**

Displays the icon of the source selected on the **[SOURCE]** screen (page 31).

2. **Category**

Displays the categories.

- You can choose the categories to display here in **[Preferences]** in rekordbox for Mac/Windows or **[Settings]** in rekordbox for iOS/Android.

3. **< (BACK)**

Returns to the previous screen.

4. **Track list**

Displays preview waveforms, artwork, and a track list of the selected hierarchical level or playlist.

- Touch a waveform in the **[Preview]** column to monitor the sound before loading the track (page 47).

- Touch an artwork to register or unregister the track to/from the Tag List (page 50).
- Touch the title row to sort the list.
- Touch  on the title row to display the sub-column selection screen and select a sub-column to be displayed. To set sub-columns you want to display in the selection list, go to **[Preferences]** in rekordbox for Mac/Windows.

Playback screen (Waveform screen)

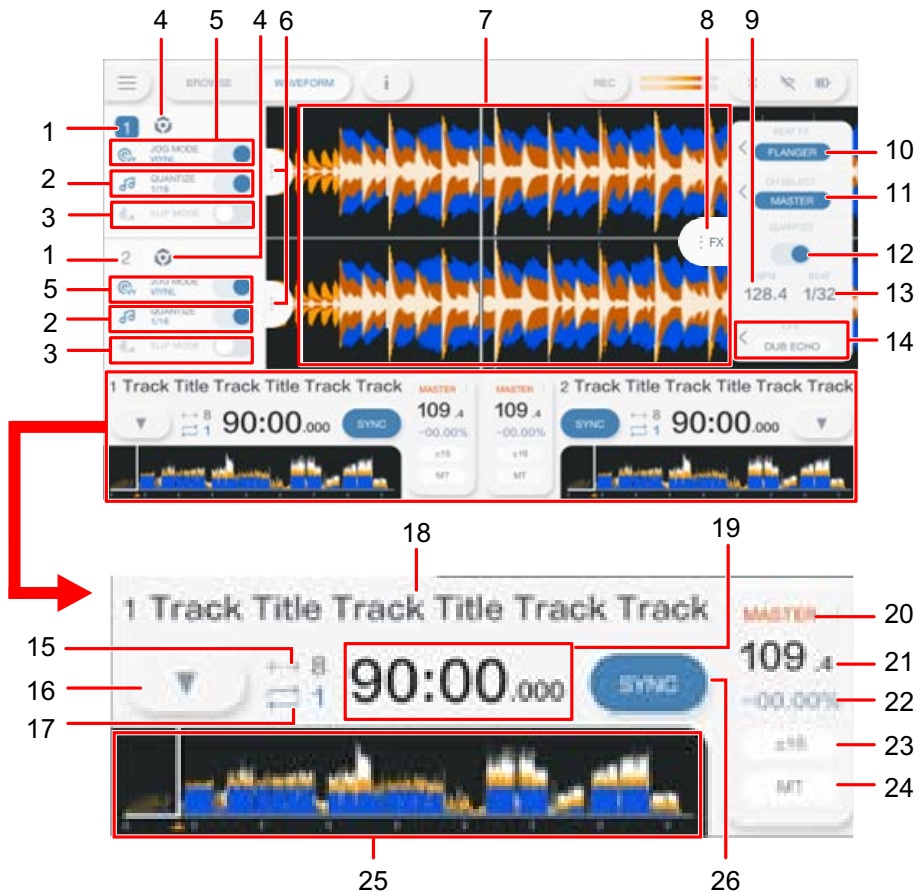

❖ Deck information panel

1. Deck number

Displays the active deck number in blue.

2. **QUANTIZE (for deck)** (page 75)

Displays **[QUANTIZE]** and the number of beats set for Quantize in blue when Quantize for the deck is turned on and active, or displays them in gray when Quantize isn't active regardless of whether it's turned on or off.

- You can change the number of beats for Quantize in [**Quantize Beat Value**] on the [**SETTINGS**] screen (page 107).

3. **SLIP MODE**

Displayed in blue when Slip is turned on and in gray when it's turned off.

4. **Source icon**

Displays the icon for the source of the track.

5. **JOG MODE**

Displayed in blue when Vinyl mode is turned on and in gray when it's turned off.

6. **Deck information tab**

Displays or hides the deck information panel.

❖ **Enlarged waveform**

7. **Enlarged waveform**

Displays the enlarged waveform, cue points, loop points, Hot Cue points, and countdown display etc. that have been analyzed by rekordbox.

Touch the enlarged waveform to switch the active deck. Touch and hold the enlarged waveform to display the [**WAVEFORM**] panel and switch between the following modes.

- Zoom mode: Zooms in and out of the upper and lower waveforms at the same time.
 - Grid Adjust mode: Adjusts the beatgrid of the track loaded in the active deck (page 78).
- You can change the waveform color in [**MY SETTINGS LOAD**] on the [**SOURCE**] screen or in [**Waveform Color**] on the [**SETTINGS**] screen (page 108).

❖ **Effect information panel**

8. **FX tab**

Displays or hides the effect information panel.

9. **BPM**

Displays BPM (Beats Per Minute, i.e. tempo) for Beat FX.

In Auto mode, the automatically detected BPM is displayed. In Manual Setting mode, the BPM is displayed in green.

10. **Beat FX**

Displays the selected Beat FX (effect name) (page 100).

11. **CH SELECT**

Selects the channel to apply Beat FX to.

12. **QUANTIZE (for Beat FX)**

Displayed in blue when Quantize for Beat FX is turned on and active or in gray when Quantize isn't active when it's turned on or off (page 103).

13. **BEAT**

Displays the number of beats set for the effect.

14. **SOUND COLOR FX**

Displays the selected Sound Color FX (page 96).

❖ **Overall waveform/playback information**

15. **Number of beats for Beat Jump**

Displays the number of beats set for Beat Jump.

16. ▼

Displays the [MEMORY CUE] panel to set the memory cue operation on (pages 65, 70).

17. **Number of beats for a loop**

Displays the number of beats set for a beat loop or a loop playing.

18. **Track name**

Displays the track name for the loaded track.

19. **Time display (minutes, seconds, msec)**

Displays remaining time or elapsed time. Touch to switch the time display between remaining time or elapsed time.

20. **MASTER indication**

Displayed when the deck is set as a master deck.

21. **BPM**

Displays BPM (beats per minute, i.e. tempo) for the track playing.

- The measured value may differ from that measured by our DJ mixers due to differences in the measurement methods. This isn't a malfunction.

22. **Playback speed**

Displays the playback speed set by the TEMPO slider.

23. **Playback speed adjustment range**

Displays the adjustable range from the original playback speed (page 57).

24. **MT indication**

Lights up when Master Tempo is turned on.

25. Overall waveform

Displays the overall waveform, cue points, loop points, and Hot Cue points, etc. that have been analyzed by rekordbox.

You can start playback from a point you touch on the waveform (page 56).

- The indicators on the overall waveform indicate the following.
 - Playing address: Shows the track as a bar graph (horizontal line). The current playback point is indicated with a white vertical line on the bar graph.
When the time display is set to **[TIME]**, the graph lights up from the left to indicate elapsed time.
When the time display is set to **[REMAIN]**, the graph goes dark from the left, so the remaining part of the track stays lit up.
 - Scale display (30-second interval): Displays scales at 30-second intervals below the playing address for tracks less than 5 minutes long.
 - Saved cue/loop points, Hot Cue/Loop points: Indicates cue/loop points and Hot Cue/Loop points saved in the track with marks above the waveform.
 - Cue/loop points: Indicates cue/loop points set in the track with marks below the waveform.
- You can change the waveform color in **[MY SETTINGS LOAD]** on the **[SOURCE]** screen or **[Waveform Color]** on the **[SETTINGS]** screen (page 108).
- You can set different colors for saved cue/loop points and Hot Cue/Loop points in rekordbox.

26. SYNC

Turns on or off Beat Sync (page 76).

Basic operations on the screen

Use the rotary selector or touch the screen to operate it.

❖ Using the rotary selector

The following functions are available.

Operation	Description
Rotate	Moves the cursor and highlights an item.
Press	Selects the highlighted item.
Press while pressing the [SHIFT] button	Displays the next level up (previous screen).

❖ Touch operations

The following functions are available.

Operation	Description	
Touch	Other than waveforms	Selects the highlighted item. <ul style="list-style-type: none"> • Touch an item to display the next level down. • Touch a track to display the [LOAD] button.
	Waveforms	Touch the overall waveform on the browse screen to monitor the sound from the touched point.
Flick	Moves left or right in the level, or scrolls up and down through the current level.	

Connections (basic styles)

Turn the unit off and disconnect the power cord before connecting other units.

Connect the power cord after all the connections are complete.

- Use the supplied power cord and AC adapter.
- Read the instruction manuals for the devices you are going to connect with the unit.

PRO DJ LINK

SD & USB Export

You can transfer audio files and management data of rekordbox for use on this unit using a storage device (SD, USB). You can play playlists or tracks with cues, loops, and Hot Cues previously set in rekordbox.

- The unit only supports the Device Library Plus format (page 17).

Rear panel of the unit

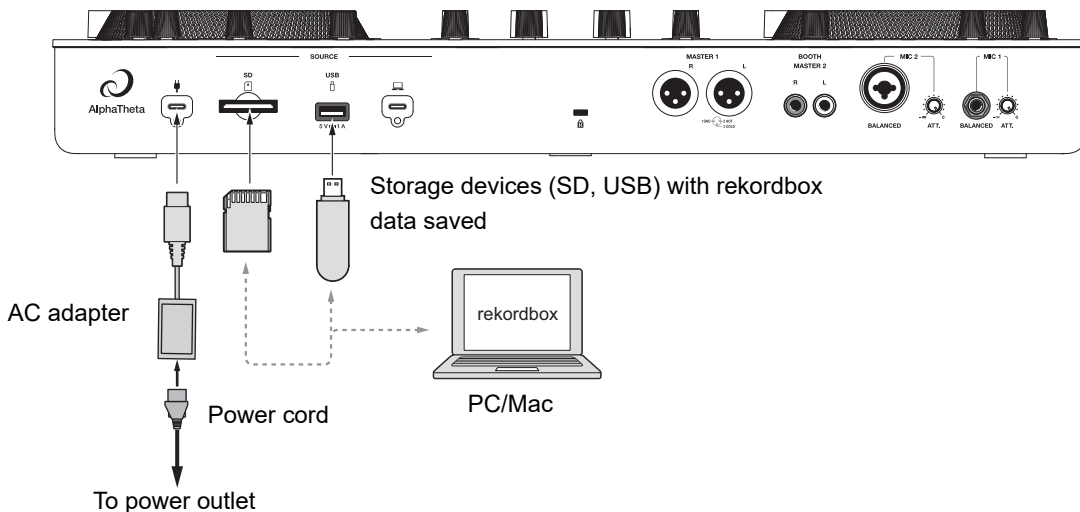

rekordbox LINK EXPORT

You can directly select and play tracks in rekordbox with this unit when the unit is connected via wireless LAN (Wi-Fi) to a PC/Mac running rekordbox for Mac/Windows or a mobile device running rekordbox for iOS/Android. You can play playlists or tracks with cues, loops, and Hot Cues previously set in rekordbox.

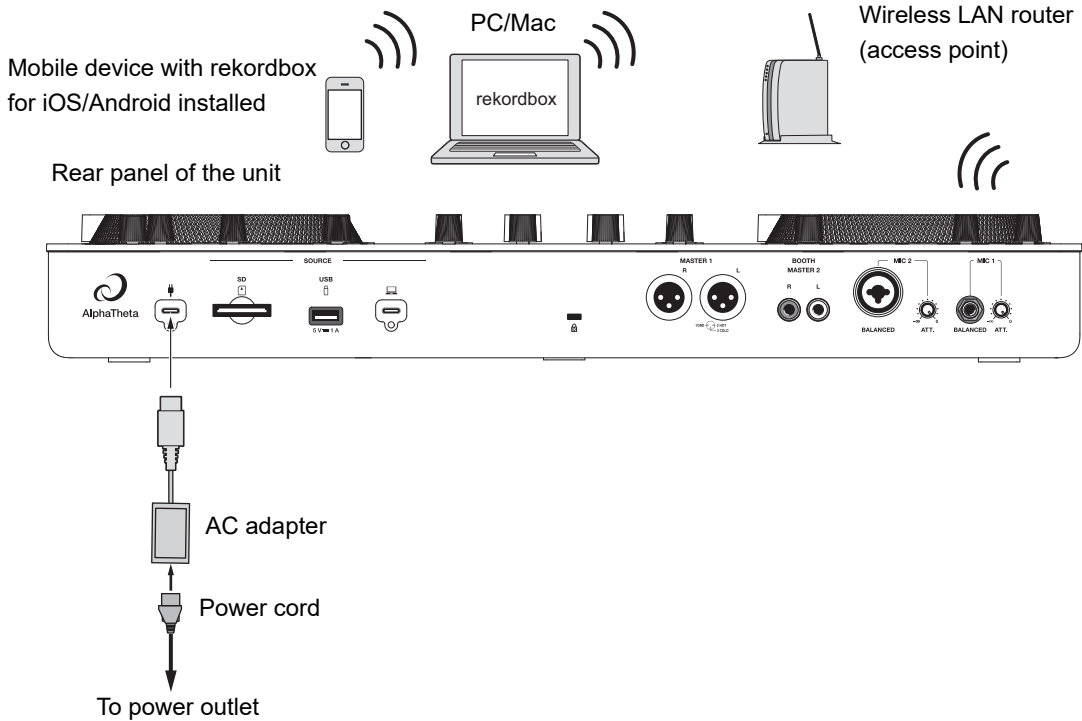

- You can't use rekordbox LINK EXPORT via a USB connection with this unit.

rekordbox CloudDirectPlay

To use rekordbox CloudDirectPlay (page 80), connect your wireless LAN router to the internet (page 122).

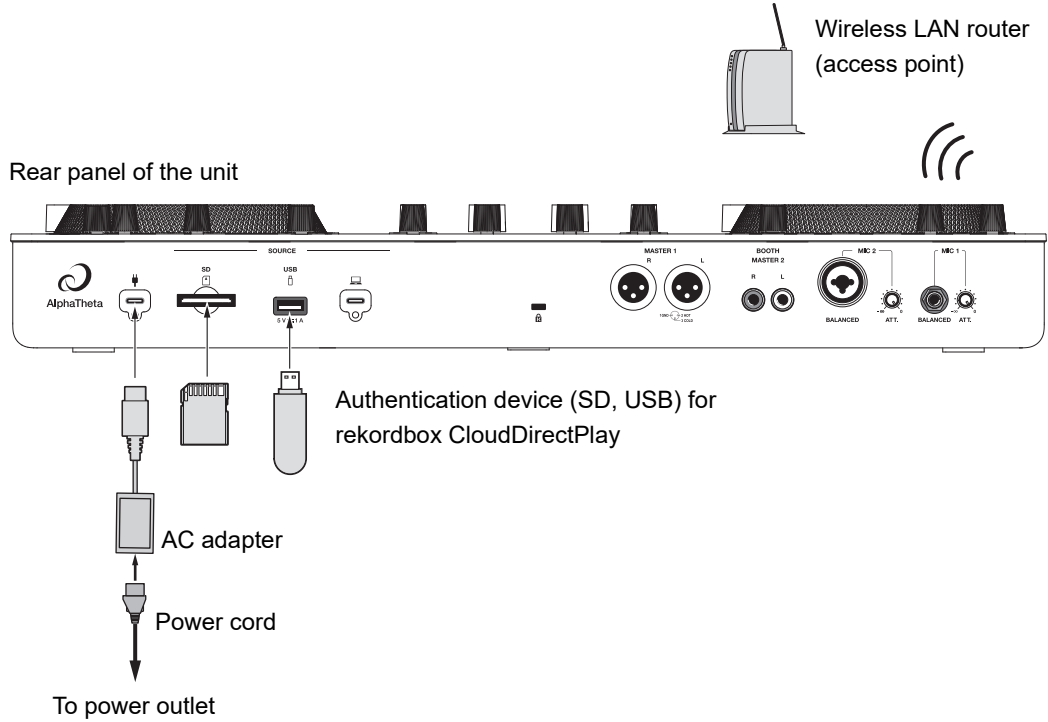

Storage device connection (SD, USB)

SD memory card

- Do not remove an SD memory card from the unit without using **[SD STOP]**. The unit's management data may be deleted or the SD memory card may become unreadable.
- Be careful not to press or pull the SD memory card with excessive force, or it may be damaged.

Inserting an SD memory card

- 1 **With the back side (terminal side) facing upward and the notch side facing away from you, insert an SD memory card and push it straight in until it locks in place.**

Removing an SD memory card

- 1 **Touch  on the title/status bar on the screen.**

The launcher screen appears.

- 2 **Touch **[SOURCE]**.**

The sources connected to the unit are displayed on the **[SOURCE]** screen (page 31).

- 3 **Touch the icon for the SD memory card, then touch **[SD STOP]**.**

- 4 **After the SD memory card disappears from the screen, push the SD memory card in.**

The card lock is released.

- 5 Pull the SD memory card out at a straight angle.

USB storage device

- Do not disconnect a USB storage device from the unit without using **[USB STOP]**. The unit's management data may be deleted or the USB storage device may become unreadable.
- Be careful not to press or pull the USB storage device with excessive force, or it may be damaged.

Connecting a USB storage device

- 1 Insert a USB storage device to the USB port at a straight angle until it stops.

Disconnecting a USB storage device

- 1 Touch  on the title/status bar on the screen.

The launcher screen appears.

- 2 Touch **[SOURCE]**.

The sources connected to the unit are displayed on the **[SOURCE]** screen (page 31).

- 3 Touch the icon for the USB storage device, then touch **[USB STOP]**.

- 4 After the USB storage device disappears from the screen, pull the USB storage device out at a straight angle.

Track selection

Browse section

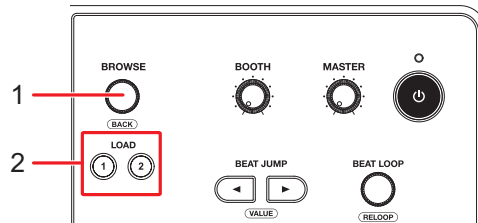

1. **Rotary selector** (page 37)
Moves the cursor or confirm the selection.
 - Press while pressing the **[SHIFT]** button to use it as the **BACK** button.
2. **LOAD 1, LOAD 2 buttons**
Loads a track to the deck (1 or 2) and starts playback.

Selecting a source

1 Touch **[SOURCE]** on the launcher screen.

Sources connected to the unit are displayed on the **[SOURCE]** screen (page 31).

2 Select a source.

Selecting a track

Selecting a track on the browse screen

1 Open the browse screen.

A track list is displayed.

🔗 Read more: Browse screen (page 32)

2 Select a track.

🔗 Read more: Loading a track to a deck (page 48)

Searching for a track

Using the Search feature

This feature is only available when browsing the rekordbox library.

1 Touch [SEARCH] on the launcher screen.

The Search screen appears.

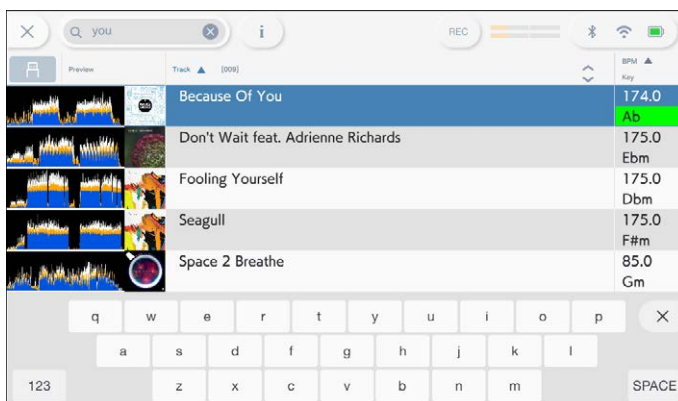

- You can display the Search screen by touching **[BROWSE]** on the launcher screen then  on the BROWSE screen.

2 Enter a keyword using the keyboard.

Tracks including the keyword are displayed in the list.

- You can specify multiple keywords by separating them with a space.

Using the Jump feature

The unit supports 2 jump modes.

❖ Alphabet Jump

1 Press and hold the rotary selector when the alphabetical order list is displayed.

Alphabet Jump mode turns on, and the first character of the highlighted track or category is displayed on the screen.

- A to Z, 0 to 9, and some symbols are displayed in Alphabet Jump mode.

2 Turn the rotary selector to scroll the screen.

The cursor jumps to the track or category whose first character is the same as the displayed character.

- The cursor doesn't jump when there are no tracks or categories whose first character is the same as the displayed character.

❖ Page Jump

1 Press and hold the rotary selector when a list other than the alphabetical order list is displayed.

Page Jump mode turns on.

2 Turn the rotary selector to scroll the screen.

The cursor jumps to the first or last track in the list on each page.

Using Track Filter

You can narrow down tracks by BPM, key, or the tag information, etc. added by rekordbox. This feature is only available when browsing the rekordbox for Mac/Windows library.

❖ Narrowing down tracks

1 Display the browse screen.

A track list is displayed.

➡ Read more: Browse screen (page 32)

2 Touch (Track Filter).

The Track Filter editing screen appears.

3 Specify the filter conditions.

- You can choose BPM, key, rating, color, or the tag information added by rekordbox as filter conditions.
- Touch to add a check mark to enable the filter conditions.
- Touch **[MASTER DECK]** to read the BPM and key of the track playing on the deck set as the sync master.
- The filter conditions are saved independently for each storage device (SD, USB).

4 Touch the switch at the top of the screen to turn the filter on.

The tracks are narrowed down by the specified conditions.

Searching by key of the track playing

The key icons of tracks which are good matches with the key (related key) of the track loaded to the master deck are displayed in green.

- This function isn't available when no deck is set as the sync master.

Monitoring sound before loading a track (Touch Preview)

You can monitor the sound of a track before loading the track.

1 Connect headphones to the unit.

➤ Read more: Front panel (page 27)

2 Touch the waveform displayed in the track list.

Monitor the sound from the touched point with your headphones.

- You can monitor the sound of a track while touching the waveform even when outputting the sound of a track that's playing on the unit.
- You can't monitor the sound of tracks which can't be loaded to the decks.

➤ Read more: Browse screen (page 32)

Loading a track to a deck

1 Select a track in the track list.

➡ Read more: Selecting a track (page 44)

2 Press the [LOAD 1] or [LOAD 2] button.

The track is loaded to the corresponding deck.

- You can load a track by touching [LOAD 1] or [LOAD 2] on the screen.

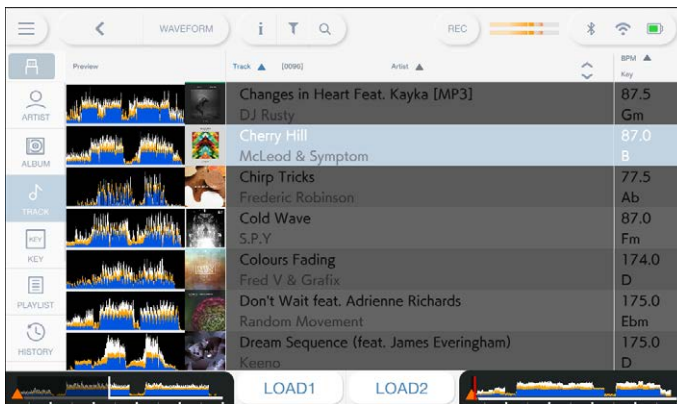

- You can't load another track while a track is playing when [Load Lock] is set to [Lock] in the Utility settings (pages 109). Set it to [Unlock], or press the [▶/||] button to pause playback, and then load another track.
- When Auto Cue is turned on, playback is paused at the start of a track. Press the [▶/||] button to start playback.

Using History

Tracks played for approximately 1 minute are recorded in the History (playback list) (up to 999 tracks).

- A new History is automatically created on a storage device (SD, USB) when it's connected to the unit.
- If you play a track more than once in succession, it may not be recorded in History.
- The information such as name of tracks recorded in History is displayed in green (indicates that the track has been played).
- You can create a playlist from the History using rekordbox. For details, refer to the rekordbox (Mac/Windows) Instruction Manual (page 8).

Viewing History

1 Touch **[BROWSE]** on the launcher screen.

The BROWSE screen appears.

2 Select **[HISTORY]** in the category.

The History list is displayed.

Deleting History

1 Touch and hold a History you want to delete in the History list.

The deletion menu appears.

2 Select **[DELETE]** or **[ALL DELETE]**.

- **[DELETE]**: Deletes the selected History.
- **[ALL DELETE]**: Deletes all History lists.

- If you create a playlist from the History using rekordbox for Mac/Windows, the HISTORY is deleted from the storage device (SD, USB).

Using the Tag List

You can tag a track you want to play next or tracks you think will work well in your performance and review them via the Tag List.

- One Tag List is created for each storage device (SD, USB) or each rekordbox CloudDirectPlay. A track can't be registered to multiple storage devices (SD, USB).
- Up to 100 tracks can be registered to the Tag List on each storage device (SD, USB).
- A track can't be registered to a Tag List more than once.

Tag list screen

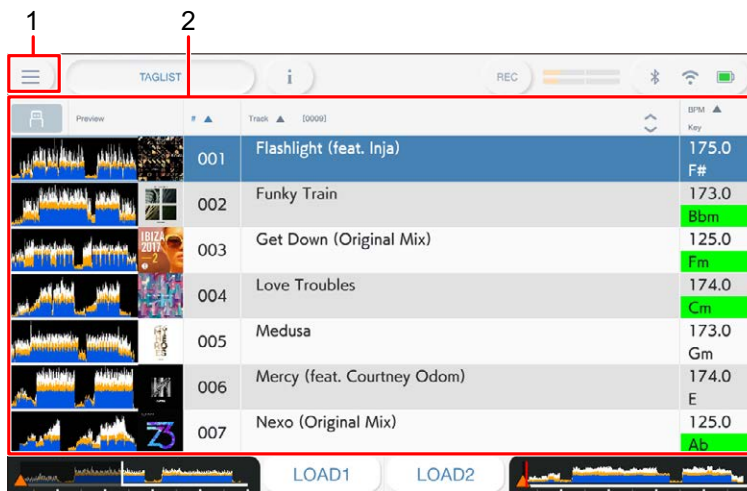

1. Source icon

Displays the icon of a source selected on the **[SOURCE]** screen (page 31).

2. Tag list

Displays the Preview waveform, artwork, serial number, and track list in the taglist.

- Touch the waveform in the **[Preview]** column to monitor the sound before loading a track (page 47).
- Touch the title row to sort the list.
- Touch  on the title row to display the sub-column selection screen and select a sub-column to be displayed. (To set sub-columns you want to display in the selection list, go to **[Preferences]** in rekordbox for Mac/Windows.)

Registering a track to the Tag List

1 Touch an artwork of a track in the track list.

A check mark is displayed for the tracks registered to the Tag List.

Deleting a track from the Tag List

❖ Deleting an individual track

1 Touch an artwork with a check mark in the track list.

The track is deleted from the Tag List.

❖ Deleting all tracks at once

1 Touch [TAGLIST] on the launcher screen.

The [TAGLIST] screen appears.

2 Touch and hold the track list.

The menu is displayed.

3 Select [REMOVE ALL].

All tracks in the Tag List are deleted.

- If you delete a track from the Tag List while playing, the track continues to play until the end. The next track won't play.

Converting the Tag List to a playlist

A playlist converted from the Tag List is displayed in the **[PLAYLIST]** category.

- You can't convert the Tag List to a playlist if the rekordbox library isn't saved on the storage device (SD, USB) or in rekordbox CloudDirectPlay.
- If a mixture of tracks – some managed and some not managed by rekordbox – are registered in the Tag List, only the tracks managed by rekordbox are converted to a playlist.

1 Touch **[TAGLIST]** on the launcher screen.

The **[TAGLIST]** screen appears.

2 Touch and hold the track list.

The menu is displayed.

3 Select **[CREATE PLAYLIST]**.

The Tag List is converted to a playlist with the name **[TAG LIST XXX]**.

Displaying the playlist screen

Playlist screen

Touch **[PLAYLIST]** on the launcher screen to display the **[PLAYLIST]** screen. You can also display the **[PLAYLIST]** screen from the browse screen (page 32).

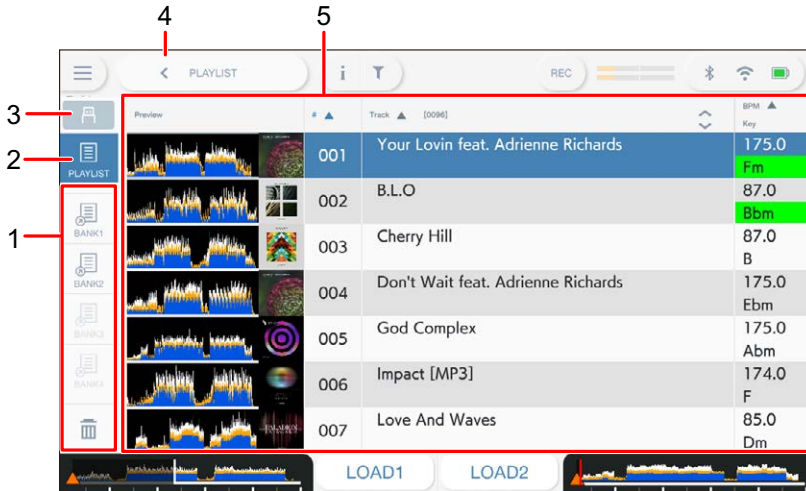

1. Playlist Bank

Displays the playlist when a playlist is registered to a Playlist Bank (page 54). With Playlist Banks, you can find a playlist without browsing the folder hierarchy.

2. Category

Displays the **[PLAYLIST]** category.

3. Source icon

Displays the icon of a source selected on the **[SOURCE]** screen (page 31).

4. < (Back)

Displays the next level up.

5. Track list

Displays the Preview waveform, artwork, serial number, and the track list in the playlist.

- Touch the waveform in the **[Preview]** column to monitor the sound before loading a track (page 47).
- Touch the title row to sort the list.

- Touch  on the title row to display the sub-column selection screen and select a sub-column to be displayed. (To set sub-columns you want to display in the selection list, go to **[Preferences]** in rekordbox for Mac/Windows.)

❖ Deleting a playlist

1 Touch and hold a playlist on the **[PLAYLIST]** screen.

The menu is displayed.

2 Select **[DELETE]** or **[ALL DELETE]**.

- **[DELETE]**: Deletes the selected playlist.
- **[ALL DELETE]**: Deletes all playlists.

Registering a playlist to a Playlist Bank

1 Highlight a playlist on the **[PLAYLIST]** screen.

2 Select a Playlist Bank whose icon is displayed in gray.

The playlist is registered to the Playlist Bank and the Playlist Bank icon changes to registered display.

- Select a Playlist Bank with a white icon to display tracks in the registered playlist.

Deregistering a playlist from a Playlist Bank

1 Select in the Playlist Bank.

Deregistration mode turns on and **X** is displayed alongside Playlist Bank icons.

2 Select the Playlist Bank to deregister the playlist from.

The playlist is deregistered and deregistration mode turns off.

Playback

Deck section

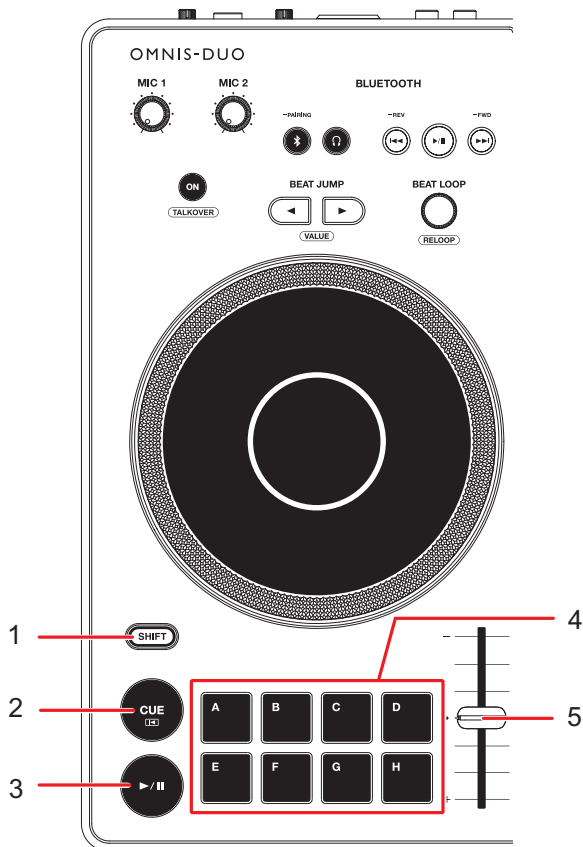

1. **SHIFT button**
2. **CUE button** (page 64)
3. **▶/|| button**
Plays or pauses a track.
4. **Hot Cue (A to H) buttons** (page 72)
5. **TEMPO slider** (page 57)

Play/pause

1 Press the [▶/⏸] button.

- During pause: Starts playing the loaded track.
- During playback: Pauses the track.
- Playback of the next track doesn't automatically start when [Play Mode] is set to [Single] in the Utility settings (page 110).
- Pausing playback in Vinyl mode mutes the sound, and in Normal mode it will output the sound intermittently (page 61).

Playing a track from the touched point on the overall waveform

1 Touch the overall waveform during pause or while pressing the top of the jog wheel in Vinyl mode.

The loaded track plays from the touched point.

- You can quickly move the playback point by sliding your finger to the point you want on the overall waveform.

Slip mode

1 Touch [SLIP MODE] on the [WAVEFORM] screen to turn Slip mode on.

If you turn Slip mode on, normal playback continues in the background (but you can't hear it) when you perform the following operations.

When you end the operation, Slip is canceled and normal playback starts from the exact point the track would have reached by then.

Function	Description
Slip Pause	If you press the [▶/] button during playback in Vinyl mode (page 61), playback continues in the background during the pause.
Slip Scratch	If you scratch a track using the jog wheel in Vinyl mode (page 61), normal playback continues in the background while you are scratching.
Slip Loop	If you start loop playback (page 68), normal playback continues in the background while the loop is playing.
Slip Hot Cue	If you press a Hot Cue (A to H) button during playback, the playback point jumps to the Hot Cue point and playback continues until you release the button. Normal playback continues in the background during Hot Cue playback.

Adjusting the playback speed (tempo control)

1 Move the TEMPO slider.

- To the [+] side: Increases the playback speed.
 - To the [-] side: Decreases the playback speed.
- Touch the variable range of the playback speed to display the [TEMPO] panel on the [WAVEFORM] screen. Touch the variable range (± 6 (0.02%), ± 10 (0.05%), ± 16 (0.05%), WIDE (0.5%)*.

The adjustable range of **[WIDE]** is $\pm 100\%$. The track stops when it's set to -100% .

* The value in parentheses indicates the adjustment unit.

Adjusting the playback speed without changing the pitch (Master Tempo)

If you turn Master Tempo on, you can change the playback speed of a track using the TEMPO slider without changing the pitch.

1 Touch the variable range of the playback speed on the **[WAVEFORM]** screen.

The **[TEMPO]** panel appears.

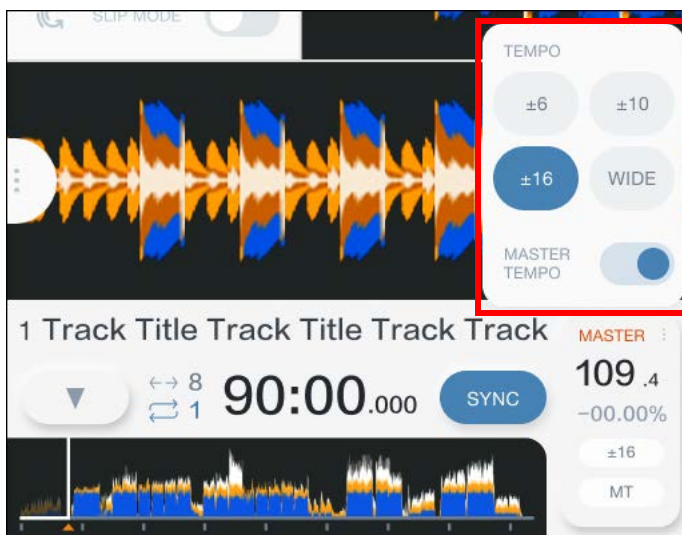

2 Touch **[MASTER TEMPO]** to turn Master Tempo on.

[MT] lights up when Master Tempo is turned on.

- Touch **[MASTER TEMPO]** again to turn Master Tempo off.

Recording

You can record the same audio as the output from the [MASTER 1] and [BOOTH/MASTER 2] terminals into a WAV file on a USB storage device.

- The recorded file name will be “REC***.WAV” (*** is a 3-digit number).
- You can’t record audio to an SD memory card.

1 Insert a USB storage device to a USB port on the unit.

➡ Read more: Storage device connection (SD, USB) (page 41)

2 Touch [REC] on the title/status bar.

The [REC] panel appears.

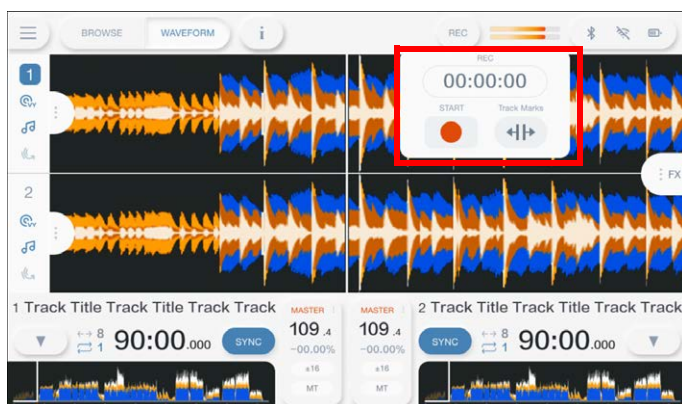

3 Touch [●(START)].

Recording starts.

- Recording isn’t available when a Bluetooth device is selected on the [SOURCE] screen.
- You can record for approximately 90 minutes on a USB storage device with 1GB of free space.
- Touch [■ (STOP)] to end recording.

Splitting a track during recording

1 Touch [REC] on the title/status bar during recording.

The [REC] panel appears.

2 Touch [⏮▶] (Track Marks).

The file is split at the point where [⏮▶] (Track Marks) is touched, and the recording continues as a new file from the split point.

Using the jog wheel

Setting the jog wheel mode

- 1 Touch [JOG MODE] on the [WAVEFORM] screen to switch the modes.



Vinyl mode turns on when the button is turned on.

- **Vinyl mode:** Stops playback with a press on the top of the jog wheel and scratches a track by turning the jog wheel while pressing the top.
- **Normal mode:** Doesn't stop playback or scratch a track with the operations of the jog wheel.

Jog wheel operations

You can use the following features in combination with the jog wheel.

Function	Description
Pitch Bend	Turn the outer section of the jog wheel clockwise during playback to increase the playback speed, and counterclockwise to decrease it. Stop turning it to resume the normal playback speed. <ul style="list-style-type: none">• In Normal mode, you can perform the same operations by turning the jog wheel while pressing the top.
Scratch	Turn the jog wheel while pressing the top during playback in Vinyl mode to scratch a track. Release the jog wheel to resume normal playback.
Frame Search	Turn the jog wheel during pause to move the pause position. <ul style="list-style-type: none">• One full rotation moves the position by 1.8 seconds.
Fast-forward/fast-reverse	Turn the jog wheel while pressing the [SHIFT] button to fast-forward or fast-reverse with extra speed.

Adjusting the playback starting and stopping speeds (for Vinyl mode)

You can adjust the following speeds.

- The speed at which playback slows down and stops after the top of the jog wheel is pressed or the [▶/||] button is pressed
- The speed at which normal playback resumes after the top of the jog wheel is released or the [▶/||] button is pressed

1 Touch [SETTINGS] on the launcher screen.

The [SETTINGS] screen appears.

2 Touch [UTILITY].

The [UTILITY] screen appears.

3 Select an adjustment setting in [Vinyl Speed Adjust].

- [Touch&Release]: Adjusts the speed at which playback slows down and stops, and normal playback resumes.
- [Touch]: Adjusts the speed at which playback slows down and stops.
- [Release]: Adjusts the speed at which normal playback resumes.

4 Touch [SETTINGS] on the launcher screen.

The [SETTINGS] screen appears.

5 Set the speed in [Vinyl Speed Adjust].

- To the left: Increases the speed.
- To the right: Decreases the speed.

Cueing

You can quickly call up a cue point you have set previously.

Setting a cue point

1 Press the [CUE] button during pause.

A cue point is set.

- Turn the jog wheel during pause to fine-adjust (0.5 frame unit) the pause position.
- If you set a new cue point, the previously set cue point is cleared.
- You can set a loop-in point if you set a loop by pressing the [BEAT LOOP] knob during playback (page 68).
- When [On] is set for [Overwrite Current Cue with Hot Cue] in the Utility settings (page 109), if you set a Hot Cue or start playback from a Hot Cue, the point is set as a cue point.

Jumping to a cue point

1 Press the [CUE] button during playback.

The track jumps to the cue point and playback is paused.

- If a comment has been set to the cue point, the comment is displayed in the track name display.

Checking a cue point (Cue Point Sampler)

1 Jump to a cue point.

- ➡ Read more: Jumping to a cue point (page 64)

2 Press and hold the [CUE] button.

Playback continues while pressing the [CUE] button.

- Press the [▶/||] button to continue playback even if you release the [CUE] button.

Saving a cue point

1 Set a cue point.

- ➡ Read more: Setting a cue point (page 64)

2 Touch [▼] on the [WAVEFORM] screen.

The [MEMORY CUE] panel appears.



3 Touch [MEM/DEL].

- If you do this during cue standby and the saved cue point is the same as the cue point in standby, the saved cue point is deleted.

Calling up a saved cue point

1 Load a track you have previously saved a cue point for.

2 Touch [▼] on the [WAVEFORM] screen.

The [MEMORY CUE] panel appears.

3 Touch [◀] or [▶].

- If a comment has been set to the called up point in rekordbox, the comment is displayed in the track name display.

Deleting a saved cue point

1 Call up a saved cue point.

➡ Read more: Calling up a saved cue point (page 66)

2 Touch [▼] on the [WAVEFORM] screen.

The [MEMORY CUE] panel appears.

3 Touch [MEM/DEL].

Setting Auto Cue

When loading a track or performing Track Search, a cue point can be automatically set to the position immediately before the first sound in the track (skipping any silence at the beginning).

1 Touch [▼] on the [WAVEFORM] screen.

The [MEMORY CUE] panel appears.

2 Touch [AUTO CUE] to turn it on.

[▼] turns to [▼ AUTO] when Auto Cue is turned on.

- The Auto Cue setting is retained even if you turn the unit off.
- You can set the sound pressure level that you want to be recognized as silence in [**Auto Cue Level**] in the Utility settings (page 109). The sound pressure level is displayed on the [MEMORY CUE] panel.

Looping

You can choose a section of a track to play repeatedly.

Setting a loop

- 1 Turn the [BEAT LOOP] knob to select the number of beats for the length of a loop.**
- 2 Press the [BEAT LOOP] knob.**

Loop playback starts according to the BPM of the track and the specified number of beats.

- If the BPM can't be detected, it's set to 120.

Adjusting the length of a loop

Halving the length of a loop

- 1 Turn the [BEAT LOOP] knob counterclockwise during loop playback.**

The loop length is halved.

Doubling a loop in length

- 1 Turn the [BEAT LOOP] knob clockwise during loop playback.**

The loop length is doubled.

Using Active Loop

Set a saved loop as an Active Loop using rekordbox beforehand.

1 Load a track that has an Active Loop set.

After the playback point passes the set point, loop playback automatically starts.

Canceling loop playback

1 Press the [BEAT LOOP] knob during loop playback.

Loop playback is canceled.

- Press the [BEAT LOOP] knob while pressing the [SHIFT] button to start loop playback from the loop-in point.

Emergency Loop

The unit automatically plays a Beat Loop if it can't start playing the next track when the end of the current track is reached. This prevents situations where your performance is interrupted by silence.

- You can't DJ during Emergency Loop playback.
- Load a track to cancel the Emergency Loop.
- When the file has been cached, Emergency Loop isn't applied and playback continues with the restriction.

Saving a loop

1 Set loop points.

➡ Read more: Setting a loop (page 68)

2 Touch [▼] on the [WAVEFORM] screen.

The [MEMORY CUE] panel appears.

3 Touch [MEM/DEL].

Calling up a saved loop

1 Load a track you have previously saved a loop for.

2 Touch [▼] on the [WAVEFORM] screen.

The [MEMORY CUE] panel appears.

3 Touch [◀] or [▶].

- If a comment is set to the called up point in rekordbox, the comment is displayed in the track name display.

Deleting a saved loop

1 Call up a saved loop.

➡ Read more: Calling up a saved loop (page 70)

2 Touch [▼] on the [WAVEFORM] screen.

The [MEMORY CUE] panel appears.

3 Touch [MEM/DEL].

- If you delete a loop set as an Active Loop, the Active Loop is also deleted.

Hot Cues

You can quickly call up a Hot Cue point by pressing the Hot Cue (**A to H**) buttons and start playback from that point in the track.

Hot Cues saved on a storage device (SD, USB) will automatically called up when tracks are loaded.

Setting a Hot Cue

1 Press one of the Hot Cue (**A to H**) buttons at the point where you want to set a Hot Cue.

A Hot Cue is set to the button.

- If you do this during loop playback, a loop is set instead.
 - When **[On]** is set for **[Overwrite Current Cue with Hot Cue]** in the Utility settings, the point is set as a cue point (page 109).
- You can set up to 8 Hot Cues per track.
 - The Hot Cue (**A to H**) displays on the screen light up as follows according to the set function. You can change the colors using rekordbox.

Set function	Color
Cue point	Green
Loop	Orange
No setting	No light

- You can't set a Hot Cue to any Hot Cue (**A to H**) buttons that have a one set already. To set a new Hot Cue, delete a one from a button first (page 73).

Starting playback from a Hot Cue point

1 Press one of the Hot Cue (A to H) buttons that have a Hot Cue set.

Playback starts from the Hot Cue point.

- When [On] is set for [Overwrite Current Cue with Hot Cue] in the Utility settings, the point is set as a cue point (page 109).
- Press the [BEAT LOOP] knob to cancel playback of the loop started with the Hot Cue (A to H) button.

Registering or deleting a Hot Cue

1 Press one of the Hot Cue (A to H) buttons while pressing the [SHIFT] button.

The Hot Cue is set to the button or deleted from the button.

Beat Jump/Loop Move

You can instantly move the playback point without changing the rhythm of a track that's playing.

Beat section

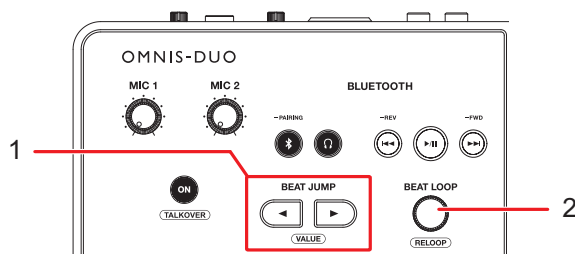

1. **BEAT JUMP ◀, ▶ buttons**

The playback point jumps forward or backward by the set number of beats from the point where you press the button.

2. **BEAT LOOP knob** (pages 68, 69)

Changes the number of beats.

Using Beat Jump/Loop Move

1 Press the [BEAT JUMP ◀] or [BEAT JUMP ▶] button during playback.

The playback point jumps by the number of beats from the point where the button is pressed.

- If you do this during loop playback, a loop is moved by the number of beats.
- To change the number of beats, press the [BEAT JUMP ◀] or [BEAT JUMP ▶] button while pressing the [SHIFT] button or turn the [BEAT LOOP] knob.

Quantize (for deck)

Cue points, loop-in points, loop-out points, and Hot Cue points are automatically set to the closest beat position even if your timing is off the beat when you set them.

You can use Hot Cues and loop, etc. without breaking the rhythm of the track you are playing.

- You can't use the Quantize feature with tracks that haven't been analyzed by rekordbox.
For details on track analysis, see the rekordbox Instruction Manual (page 8).
- You can set [**Quantize Beat Value**] on the [**SETTINGS**] screen (page 107).
- The number of beats set for Quantize is displayed on the deck information panel.

Using Quantize

1 Touch the deck information tab on the [WAVEFORM] screen to display the deck information panel.

2 Touch [QUANTIZE] to turn it on.

Quantize turns on and the [QUANTIZE] icon is displayed in blue.

- Touch [QUANTIZE] again to turn Quantize off.

Beat Sync

If you turn Beat Sync on, tempo (BPM) and beat position of tracks on the unit automatically synchronize.

- Beat Sync can't be used with tracks that haven't been analyzed by rekordbox.
- You can set rekordbox for Mac/Windows as the sync master. For details, see the rekordbox Instruction Manual (page 8).

Using Beat Sync

1 Play a track analyzed by rekordbox on the deck you want to set as the sync master.

The deck is set as the sync master and **[MASTER]** is displayed on the **[WAVEFORM]** screen.

2 Play a track analyzed by rekordbox on the deck you want to sync with the sync master.

3 Touch **[SYNC]** on the deck you want to sync with the sync master.

Beat Sync turns on.

- Touch **[SYNC]** again to turn Beat Sync off.
- If the position of the TEMPO slider doesn't match the playback tempo (BPM), the Beat Sync tempo is maintained. To restore normal use of the TEMPO slider, load the track again or move the slider until the BPM matches the playback tempo. After this, you'll be able to use the TEMPO slider to adjust the tempo.

Using Instant Doubles

You can duplicate a track loaded on DECK 1 or DECK 2 so it plays on the other deck from exactly the same point.

- 1 Press the [LOAD] button ([LOAD 1] or [LOAD 2]) twice on the deck where you want the duplicate track to start playing.**

Beatgrid

You can adjust the beatgrid.

- You can't adjust the beatgrid for tracks that haven't been analyzed by rekordbox.

Adjusting the beatgrid

1 Press and hold the rotary selector on the [WAVEFORM] screen.

The [WAVEFORM] panel appears.

- You can also display the [WAVEFORM] panel by touching and holding the waveform.

2 Touch [GRID ADJUST] to display the [GRID ADJUST] panel.

3 Turn the rotary selector to adjust the beatgrid.

- You can adjust the beatgrid on the active deck.
- You can also adjust the beatgrid using the following on the Grid Adjust panel.
 - **[SNAP GRID(CUE)]**: Moves the first beat position to a cue point.
 - **[SHIFT GRID]**: Applies the settings (Pitch Bend, etc.) adjusted during synchronization.
 - **[<1/2], [1/2>]**: Moves the beatgrid by 1/2 beat.
- Touch **[RESET]** to reset to the original beatgrid.

Cloud

You can use rekordbox CloudDirectPlay if you connect the unit to the internet via wireless LAN (Wi-Fi) (page 122).

rekordbox CloudDirectPlay

With rekordbox CloudDirectPlay, you can load and play audio files you've previously uploaded to your cloud storage onto the unit.

- Use Cloud Library Sync to upload audio files to your cloud storage. You can then play the uploaded files via your PC/Mac, mobile device, or this unit.
- For information on Cloud Library Sync, see the Cloud Library Sync Operation Guide.

rekordbox.com/manual

- For information on how to manage audio files uploaded to your cloud storage, refer to the URL below.

rekordbox.com

❖ rekordbox version

Install the latest version of rekordbox for Mac/Windows to use rekordbox CloudDirectPlay with this unit.

❖ Subscription

You can use rekordbox CloudDirectPlay with all rekordbox subscription plans, including the Free plan.

- For information on rekordbox plans, see the plan page at the URL below.

rekordbox.com

❖ Cloud storage service

rekordbox CloudDirectPlay uses the cloud storage service (Dropbox) used by Cloud Library Sync.

- Cloud Library Sync and rekordbox CloudDirectPlay support Dropbox and Google Drive. This unit only supports Dropbox. If you are using Google Drive, log in to Dropbox from rekordbox and upload audio files to Dropbox to use.
- For more information, see the operation guides for Cloud Library Sync and rekordbox CloudDirectPlay.

rekordbox.com/manual

❖ Transmission speed

The time it takes to sync your library and load audio files via rekordbox CloudDirectPlay depends on the speed of your internet connection. We recommend a line speed of 20 Mbps or faster for using rekordbox CloudDirectPlay.

❖ Personal use

With rekordbox CloudDirectPlay, you can use your rekordbox library on multiple PCs/Macs, mobile devices, and this unit, but you can't share your library with other users.

Using rekordbox CloudDirectPlay

1 Click [MY PAGE] at the top right of the rekordbox for Mac/Windows screen.

The [MY PAGE] screen appears.

2 Click the [CLOUD] tab.

3 Check if [Sync the library with other devices] is turned on in [Cloud Library Sync].

4 Turn on [Using device authentication] and [Use rekordbox CloudDirectPlay].

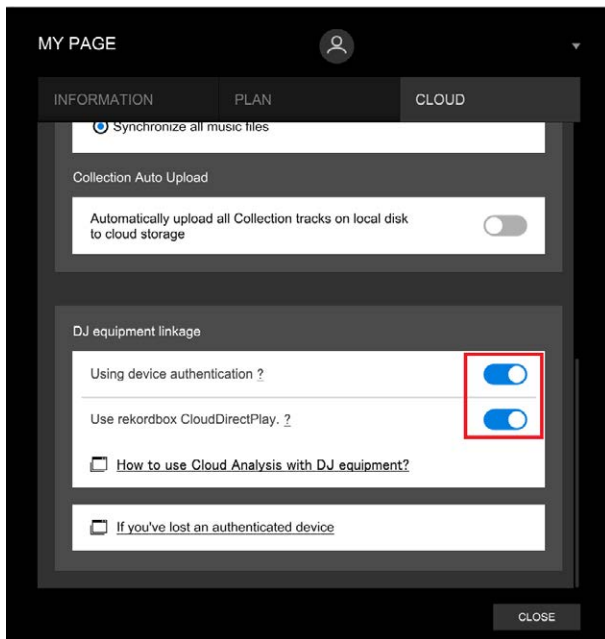

The conversion of the library starts on the cloud server.

After the conversion completes, [Auth] (authentication button) is displayed on the right of the device name in the tree view.

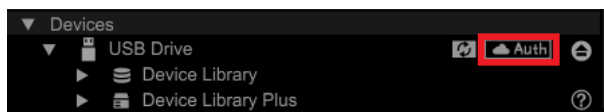

- Depending on the number of audio files in the library, it may take some time to convert the library.
- If the library conversion fails, [Use rekordbox CloudDirectPlay] is automatically turned off. If the conversion error happens repeatedly, contact us for support via the URL below.
rekordbox.com/
- If you turn off [Use rekordbox CloudDirectPlay], the authentication for all devices used with the same account is canceled.
- If you turn off [Use rekordbox CloudDirectPlay] and turn it on, the library is converted again.

Authentication device for rekordbox CloudDirectPlay

To play audio files with the unit via rekordbox CloudDirectPlay, prepare a storage device (SD, USB) to use for authentication.

Connect the storage device (SD, USB) to your PC/Mac and perform the authentication procedure below.

❖ Authenticating the storage device (SD, USB)

- 1 **Connect the storage device (SD, USB) to your PC/Mac.**
- 2 **Click [Auth] (authentication button) on the right of the device name in the tree view.**

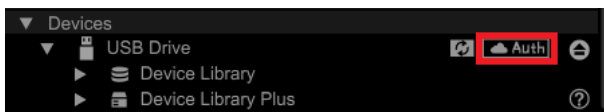

After the authentication completes, [Auth] (authentication button) changes to  (authenticated icon).

Logging in to CloudDirectPlay

1 Connect the authentication device (SD, USB) for rekordbox CloudDirectPlay to the unit.

If the connected device is valid, the device name is displayed on the [SOURCE] screen.

2 Touch [LOG IN] on the information display for the authentication device (SD, USB).

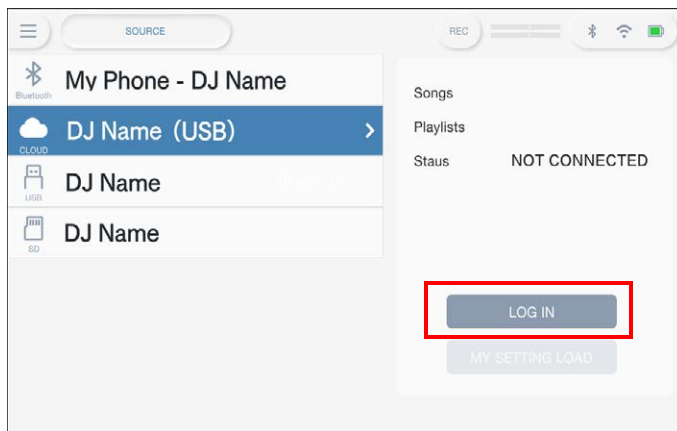

Now you can use rekordbox CloudDirectPlay.

Playing audio files via rekordbox CloudDirectPlay

When rekordbox CloudDirectPlay is selected on the **[SOURCE]** screen, you can play audio files uploaded to the cloud storage from the browse screen of the unit.

- The time it takes to load audio files depends on the speed of your internet connection. You can view the loading progress in the overall waveform on the **[WAVEFORM]** screen.
- The following playback functions are only available for audio files loaded from rekordbox CloudDirectPlay.
 - Memory Cue/Loop
 - Hot Cue/Loop point
- Audio files are loaded one by one from the track list. The **[Continue]** function in Play mode isn't available.
- The following functions aren't available for rekordbox CloudDirectPlay.
 - Touch Preview
 - Intelligent playlist
- While using rekordbox CloudDirectPlay, any track information changed by other rekordbox CloudDirectPlay or Cloud Library Sync devices used with the same account isn't reflected until you log out of rekordbox CloudDirectPlay and log in again.

Logging out of rekordbox CloudDirectPlay

- 1 On the **[SOURCE]** screen, touch **[LOG OUT]** on the information display for the authentication device (SD, USB).

Deauthenticating the authentication device (SD, USB)

- 1 Click  (authenticated icon) on the right of the device name in the tree view.

The authentication device (SD, USB) is deauthenticated.

- If the authentication device (SD, USB) has been authenticated with a rekordbox account other than the one you're currently using, perform the procedure with the other account.
- If the authentication device (SD, USB) has been authenticated with another user's account:
 - Connect the authentication device (SD, USB) to the PC/Mac of the user who performed the authentication for the device, then deauthenticate it.
 - Access the website from the PC/Mac of the person who performed the authentication for the device, then deauthenticate it (page 85).

❖ Deauthenticating the authentication device (SD, USB) from the website

You can deauthenticate the authentication device (SD, USB) from the website, for example, if you lose the device.

- 1 Click [MY PAGE] at the top right of the rekordbox for Mac/Windows screen.

The [MY PAGE] screen appears.

- 2 Click the [CLOUD] tab.
- 3 Click [If you've lost an authenticated device].

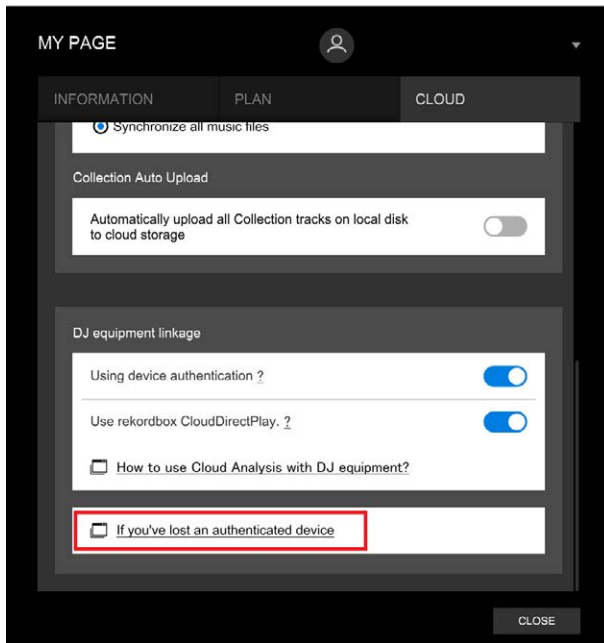

The website is displayed in the browser.

4 Follow the instructions on the website to deauthenticate the device.

- You can't deauthenticate devices authenticated with other accounts. You'll always need to perform the procedure with the account which authenticated the device.

Audio output

Follow the procedures below to output and adjust sound.

- Outputting sound (page 88)
- Adjusting the sound (page 89)
- Setting the faders (page 89)

Channel section/master section

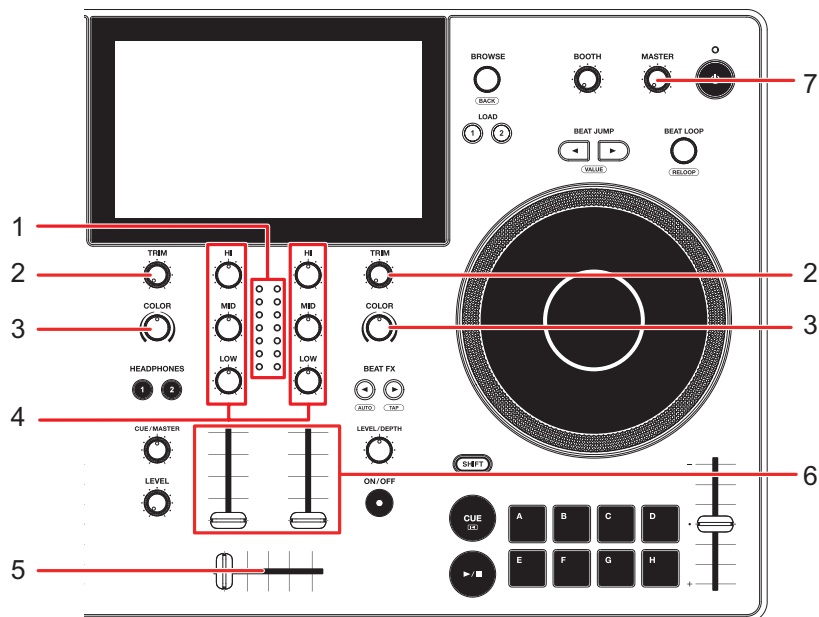

❖ Channel section

1. Channel level indicator

Displays the volume level before the sound passes through the channel fader.

2. TRIM knob

Adjusts the volume for the channel input sound.

3. COLOR knob (page 96)

4. EQ/ISO (HI, MID, LOW) knobs

Adjusts the volume of each frequency band.

Each knob adjusts in the following range.

- [HI]: -∞ dB to +6 dB (ISO)/-26 dB to 6 dB (EQ)

- **[MID]**: $-\infty$ dB to +6 dB (ISO)/-26 dB to 6 dB (EQ)
- **[LOW]**: $-\infty$ dB to +6 dB (ISO)/-26 dB to 6 dB (EQ)

5. **Crossfader**

Adjusts the volume balance between the channel output sounds according to the crossfader curve specified with **[Crossfader Curve]** on the **[SETTINGS]** screen (page 107).

6. **Channel fader**

Adjusts the volume for the channel output sound according to the channel fader curve set with **[Channel Fader Curve]** on the **[SETTINGS]** screen (page 107). Moving it up increases the volume, and down decreases the volume.

❖ **Master section**

7. **MASTER level knob**

Adjusts the volume for the master sound.

Outputting sound

Adjusting the channel input volume

1 Turn the **[TRIM]** knob to adjust the volume for the input sound.

The channel level indicator lights up when sound is input to the channel.

Adjusting the channel output volume

1 Move the channel fader to adjust the volume for the output sound.

2 Move the crossfader to adjust the volume balance of the 2 channels.

Adjusting the master sound volume

- 1 Turn the **MASTER** level knob to adjust the volume for the master sound.

The master level indicator lights up when the master sound is output.



Adjusting the sound

- 1 Turn the **EQ/ISO (HI, MID, LOW)** knobs to adjust the volume of each band.
- Set the function (equalizer or isolator) to adjust with the EQ/ISO (HI, MID, LOW) knob in [EQ/ISO] on the [SETTINGS] screen (page 107).

Setting the faders

Set the channel fader and crossfader.

Setting the channel fader



- 1 Touch [SETTINGS] on the launcher screen.
- 2 Set the channel fader curve in [Channel Fader Curve].
 -  : Steeply raises the volume when the channel fader is moved close to the top position.
 -  : Gradually raises the volume as the channel fader is moved up.
 -  : Steeply raises the volume as the channel fader is moved from the bottom position.

 Read more: Channel Fader Curve (page 107)

Setting the crossfader

1 Touch [SETTINGS] on the launcher screen.

2 Set the crossfader curve in [Crossfader Curve].

- **THRU**: Outputs sounds from Deck 1 and Deck 2 regardless of the crossfader position.
- : Gradually raises the volume of the sound assigned to the other side as the crossfader is moved from one side (Deck 1 or Deck 2 side) to the other, and decreases the volume of the sound on the side it is moving away from.
- : Steeply raises the volume of the sound assigned to the other side as the crossfader is moved from one side (Deck 1 or Deck 2 side) to the other.

 Read more: Crossfader Curve (page 107)

Monitoring sound

Headphones section

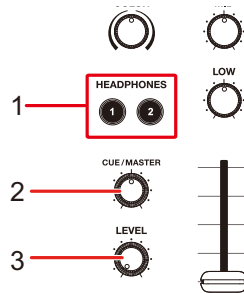

1. **HEADPHONES 1, 2 buttons**

Selects the channel to output sound from headphones.

2. **CUE/MASTER knob**

Adjusts the volume balance between the master sound, Touch Preview sound and the channel selected with the [**HEADPHONES 1, 2**] buttons.

- Set the knob all the way to the left to monitor only the channel sound/Touch Preview sound, and all the way to the right to monitor only the master sound.

3. **LEVEL knob**

Adjusts the volume for sound output from the [**PHONES**] terminals.

Monitoring with headphones

1 Connect headphones to one of the PHONES terminals.

➡ Read more: Front panel (page 27)

2 Press the [CUE] button to select the channel to monitor.

- This operation isn't necessary when monitoring the sound of Touch Preview.
- Set the headphones output sound (MONO SPLIT/STEREO) in [Headphones] on the [SETTINGS] screen (page 107).

3 Turn the [CUE/MASTER] knob to adjust the volume balance between the channel sound and the master sound.

4 Turn the [LEVEL] knob to adjust the volume.

Booth section

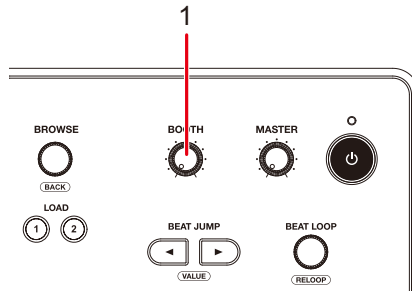

1. BOOTH level knob

Adjusts the volume for the sound output to a booth monitor.

Using a booth monitor

1 Connect a booth monitor to the [BOOTH/MASTER 2] terminals.

- [BOOTH/MASTER 2] is shared terminals. When using as booth terminals, set [Booth/Master 2 Setting] to [Booth] in the Utility setting (page 110).

➡ Read more: Rear panel (page 27)

2 Turn the BOOTH level knob to adjust the volume for the output sound.

Microphone

MIC section

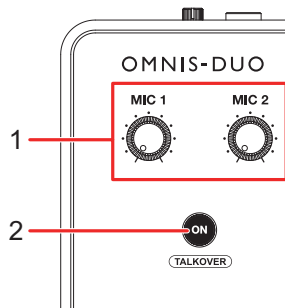

1. MIC 1, MIC 2 knobs

Adjusts the volume of sound input from the [MIC 1] or [MIC 2] terminal.

2. ON button

Sets the microphone sound output.

Press while pressing the [SHIFT] button to turn Talkover mode on.

Press and hold to turn Push To Talk on. The microphone is turned on while pressing the button.

- The indicator on the button indicates the microphone sound output as follows.
 - Off: The microphone is off.
 - Lights up: The microphone is on.
 - Blinks: The microphone talkover is on. When audio is input to the microphone, the volume of all channels other than the microphone channel is attenuated by -24 dB.

Using a microphone

1 Connect a microphone to the [MIC 1] or [MIC 2] terminal.

- Microphone gain varies depending on the microphone you use. Adjust the sound level according to your microphone with the [ATT.] knob on the rear of the unit before using it (page 27).

2 Press the [ON] button.

The microphone turns on.

- Press the button again to turn the microphone off.
- Press and hold the [ON] button to turn Push To Talk on. The microphone is turned on while pressing the button. Release the button to turn the microphone off.

3 Turn the [MIC 1] or [MIC 2] knob to adjust the microphone volume level.

- Note that turning the knob too far clockwise outputs the sound at a high volume.

4 Touch [SETTINGS] on the launcher screen.

The [SETTINGS] screen appears.

5 Adjust the volume of each band in [MIC EQ HIGH] or [MIC EQ LOW].

Touch to adjust the volume of sound input from the [MIC 1] or [MIC 2] terminal.

Each setting adjusts in the following range.

- [HIGH]: -12 dB to +12 dB (10 kHz)
- [LOW]: -12 dB to +12 dB (100 Hz)

6 Speak into the microphone.

Sound Color FX

Sound Color FX section

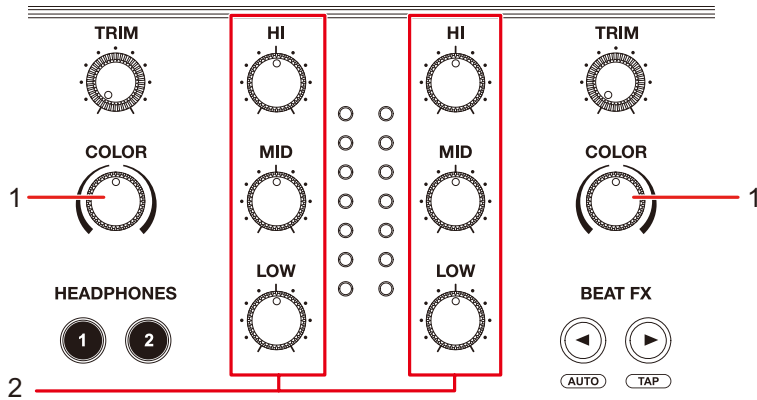

1. **COLOR knob**
Adjusts a filter or an effect.
2. **EQ/ISO (HI, MID, LOW) knobs** (page 87)

Using Sound Color FX

➤ Read more: Sound Color FX types and settings (page 98)

1 Touch the [FX] tab on the [WAVEFORM] screen.

The effect information panel appears.

2 Touch [SOUND COLOR FX].

The SOUND COLOR FX panel appears.



3 Touch an effect.

The selected effect button lights up, and the selected effect is applied to CH 1/CH 2.

4 Turn the [COLOR] knob to adjust the effect.

The effect on the channel you turned the knob for is adjusted.

- Touch the button of the effect you're using again to turn the effect off.
- The quantitative parameter for the effect is automatically adjusted.

Sound Color FX types and settings

You can adjust the following settings with the knobs.

Effect/operation	Description
SPACE	Adds reverberation to the original sound.
<ul style="list-style-type: none"> • COLOR: 	Turn counterclockwise to add reverberation to the middle frequency range and low frequency range. Turn clockwise to add reverberation to the middle frequency range and high frequency range.
DUB ECHO	Adds reverberating echo by outputting the sounds slightly delayed from the original sound several times and attenuating them.
<ul style="list-style-type: none"> • COLOR: 	Turn counterclockwise to add reverberating echo to the middle frequency range. Turn clockwise to add reverberating echo to the high frequency range.
SWEEP	Adds a gate effect (makes the sound tighter and reduces the volume) or a bandpass filter effect.
<ul style="list-style-type: none"> • COLOR: 	Turn counterclockwise to add a gate effect. Turn clockwise to gradually narrow the bandwidth of the bandpass filter.
NOISE	Outputs filtered white noise mixed with the sound of the channel.
<ul style="list-style-type: none"> • COLOR: 	Turn counterclockwise to lower the cut-off frequency for the filter which passes white noise through. Turn clockwise to raise the cut-off frequency for the filter which passes white noise through.
<ul style="list-style-type: none"> • EQ/ISO (HI, MID, LOW): 	Volume of the noise

Effect/operation	Description
CRUSH	Outputs a 'crushed' version of the original sound.
<ul style="list-style-type: none">• COLOR:	Turn counterclockwise to apply "crushed" effect to the sound. Turn clockwise to crush sound and apply the high-pass filter effect.
FILTER	Outputs filtered sound.
<ul style="list-style-type: none">• COLOR:	Turn counterclockwise to lower the cut-off frequency of the low-pass filter. Turn clockwise to raise the cut-off frequency of the high-pass filter.

Beat FX

Beat FX section

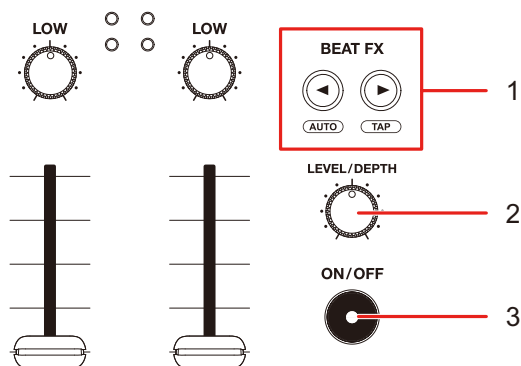

1. BEAT ◀, ▶ button

Sets the number of beats for Beat FX.

- Press the [▶] button while pressing the [SHIFT] button to manually set BPM (Tap mode).
- Press the [◀] button while pressing the [SHIFT] button to automatically set BPM.
- Auto BPM is set when the unit turns on.

2. LEVEL/DEPTH knob

- Turn the knob all the way counterclockwise to output the original sound.

3. ON/OFF button

Turns Beat FX on and off. The button blinks when the effect is turned on.

Using Beat FX

➤ Read more: Beat FX types and settings (page 104)

1 Touch [FX] on the [WAVEFORM] screen.

The effect information panel appears.

2 Touch [BEAT FX].

The [BEAT FX] panel appears.

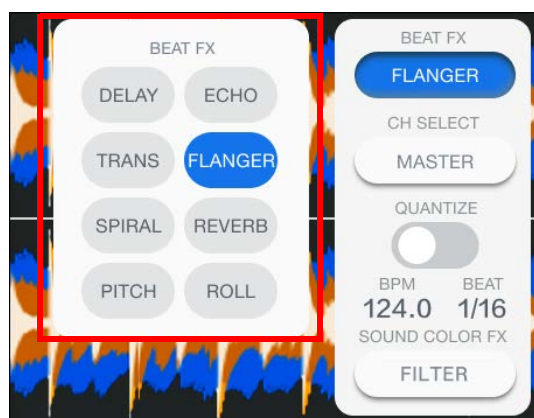

3 Touch an effect.

4 Touch [CH SELECT] on the effect information panel.

The [CH SELECT] panel appears.

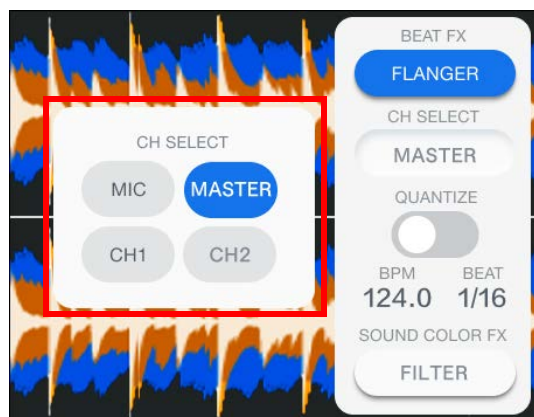

- 5 Touch a channel to apply the Beat FX to.
- 6 Press the [BEAT ◀] or [BEAT ▶] button to set the number of beats to synchronize the effect with.
- 7 Turn the [LEVEL/DEPTH] knob to adjust the effect.
- 8 Press the [ON/OFF] button to turn the Beat FX on.

The Beat FX is applied to the selected channel.

- Press the [ON/OFF] button again to turn the Beat FX off.

Setting BPM manually (Tap mode)

- 1 Tap [▶] while pressing the [SHIFT] button more than twice in time with the beat of the track.

BPM is set according to the average time between taps.

- The length of one beat is set as the effect time when you set BPM with the [▶] button.
- Press the [◀] button while pressing the [SHIFT] button to automatically set the BPM.

Using Quantize (for Beat FX)

If you use Quantize, the unit adds an effect by automatically synchronizing it with the beat according to the track's grid information analyzed by rekordbox. This happens even if you operate the [ON/OFF] button of Beat FX roughly.

- Analyze the tracks in rekordbox beforehand. For details on track analysis, see the rekordbox Instruction Manual (page 8).

1 Touch the [FX] tab on the [WAVEFORM] screen.

The effect information panel appears.

2 Touch [QUANTIZE] to turn it on.

Beat FX types and settings

You can adjust the following settings with the buttons and knobs.

Beat FX/operation	Description
DELAY ¹ ²	Outputs a delay sound once according to the beat.
<ul style="list-style-type: none"> • BEAT ◀, ▶: Delay time (1/16 to 16 beats) • LEVEL/DEPTH: Balance between the original sound and the effected sound 	
ECHO ¹ ²	Outputs a delay sound several times while attenuating it according to the beat.
<ul style="list-style-type: none"> • BEAT ◀, ▶: Delay time (1/16 to 16 beats) • LEVEL/DEPTH: Balance between the original sound and the effected sound 	
SPIRAL ¹ ²	Adds reverberation to the input sound. The pitch changes as the delay time changes.
<ul style="list-style-type: none"> • BEAT ◀, ▶: Delay time (1/16 to 16 beats) • LEVEL/DEPTH: Balance between the original sound and the effected sound, and feedback 	
REVERB ¹ ²	Adds reverberation to the input sound.
<ul style="list-style-type: none"> • BEAT ◀, ▶: Reverberation level (1 to 100%) • LEVEL/DEPTH: Balance between the original sound and the effected sound 	
TRANS	Cyclically cuts the sound according to the beat.
<ul style="list-style-type: none"> • BEAT ◀, ▶: Cycle of the cut (1/16 to 16 beats) • LEVEL/DEPTH: Balance between the original sound and the effected sound, and the length of time to cut the sound 	

Beat FX/operation	Description
FLANGER	Adds a cyclic flanger effect according to the beat.
• BEAT ◀, ▶:	Effect rate (1/16 to 64 beats)
• LEVEL/DEPTH:	Effect level
PITCH	Changes the pitch of the original sound.
• BEAT ◀, ▶:	Pitch of the effect sound (-50 to 100%)
• LEVEL/DEPTH:	Pitch of the effect sound
ROLL	Records the input sound when the effect is turned on, and outputs the recorded sound repeatedly according to the specified number of beats.
• BEAT ◀, ▶:	Effect time (1/16 to 16 beats)
• LEVEL/DEPTH:	Balance between the original sound and the effected sound

- ¹ When [CH SELECT] for Beat FX is set to CH 1/CH 2, you can't monitor the effected sound even if you press the [CUE] button for the relevant channel.
- ² Only the effect sound remains if you set the channel fader to the [0] position to cut the input sound (the effect sound remains even after the effect is turned off).

Settings

You can change the settings of the unit from the **[SETTINGS]** screen, the Utility menu, or on the **[PORTABILITY]** screen.

If you save My Settings (function settings of the unit) to a storage device (SD, USB), you can load them to the unit immediately when you arrive in the booth or take over from another DJ, etc.

Changing the settings from the **SETTINGS** screen

1 Touch **[SETTINGS]** on the launcher screen.

The **[SETTINGS]** screen appears.







2 Touch a setting value.

➡ Read more: **SETTINGS** menu (page 107)

- Touch **X** on the title/status bar to close the **[SETTINGS]** screen.

SETTINGS menu

*: Factory setting

Setting item	Description
MIC	
MIC EQ HIGH	Adjusts the volume of sound (-12 dB to +12 dB (10 kHz)) input from the [MIC 1] or [MIC 2] terminal.
MIC EQ LOW	Adjusts the volume of sound (-12 dB to +12 dB (100 Hz)) input from the [MIC 1] or [MIC 2] terminal.
DECK	
Quantize Beat Value	Sets the number of beats for Quantize. <ul style="list-style-type: none"> Setting values: 1/8, 1/4, 1/2, 1*
Vinyl Speed Adjust	Sets the playback and stop speeds in Vinyl mode (page 63). <ul style="list-style-type: none"> Setting values: 1, 2, 3*, 4, 5
MIXER	
EQ/ISO	Sets the function (equalizer or isolator) to adjust with the EQ/ISO (HI, MID, LOW) knobs. <ul style="list-style-type: none"> Setting values: EQ*, ISO
Headphones	Sets the output method ([Mono Split] or [Stereo]) for the headphones monitor sound. <ul style="list-style-type: none"> Setting values: MONO SPLIT, STEREO*
Channel Fader Curve	Sets the channel fader curve (page 89). <ul style="list-style-type: none"> Setting values:  Curve1,  Curve2*,  Curve3
Crossfader Curve	Sets the crossfader curve (page 90). <ul style="list-style-type: none"> Setting values: THRU,  Curve2,  Curve3*

Setting item	Description
WAVEFORM	
Waveform Color	<p>Sets the waveform color.</p> <ul style="list-style-type: none"> Setting values: BLUE, RGB, 3BAND*
Waveform Current Position	<p>Sets where to display the current playback point (center or left) on the waveform.</p> <ul style="list-style-type: none"> Setting values: LEFT*, CENTER

Changing the settings from the UTILITY screen

1 Touch [SETTINGS] on the launcher screen.

The [SETTINGS] screen appears.

2 Touch [UTILITY].

The [UTILITY] screen appears.

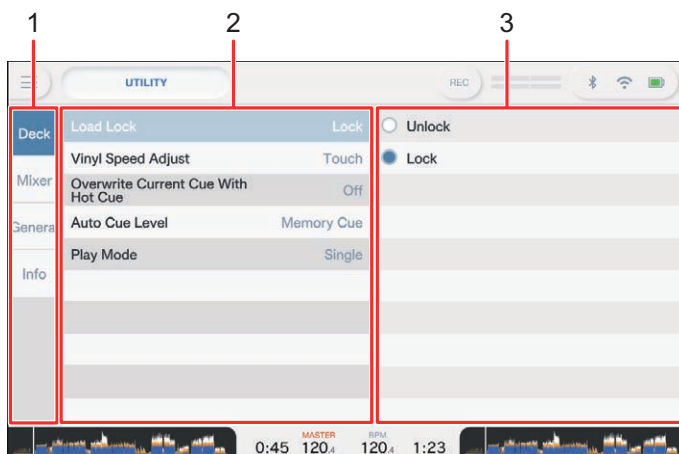

1. **Category**
2. **Setting items and current setting values**
3. **Setting values**

3 Select a category.

4 Select a setting item.

👉 Read more: Utility menu (page 109)

5 Select a setting value.

- Touch **X** on the title/status bar to close the [UTILITY] screen.

Utility menu

❖ DECK

*: Factory setting

Setting item	Description
Load Lock	<p>Determines whether or not you can load another track during playback.</p> <ul style="list-style-type: none"> • Setting values: Unlock*, Lock
Vinyl Speed Adjust	<p>Sets the adjustment method for the playback and stop speeds in Vinyl mode (page 63).</p> <ul style="list-style-type: none"> • Setting values: Touch&Release, Touch*, Release
Overwrite Current Cue with Hot Cue	<p>Determines whether or not a cue point is automatically set when a Hot Cue/Loop is set or playback starts from a Hot Cue/Loop (pages 72, 73).</p> <ul style="list-style-type: none"> • Setting values: Off*, On
Auto Cue Level	<p>Sets the sound pressure level that Auto Cue recognizes as silence.</p> <ul style="list-style-type: none"> • Setting values: -78dB, -72dB, -66dB, -60dB, -54dB, -48dB, -42dB, -36dB, Memory Cue*, Hot Cue • [Memory Cue]: Sets the saved cue/loop point closest to the beginning of a track to an Auto Cue point. • [Hot Cue]: Sets the saved Hot Cue/Loop point closest to the beginning of a track to an Auto Cue point. [▼] turns [▼ AUTO] on the [WAVEFORM] screen when Auto Cue is turned on.

Setting item	Description
	Sets playback mode.
	<ul style="list-style-type: none"> Setting values: Continue, Single*
Play Mode	<ul style="list-style-type: none"> [Continue]: Automatically loads the next track when playback reaches the end of a track. [Single]: Stops playback when playback reaches the end of a track. The next track isn't automatically loaded.

❖ MIXER

*: Factory setting

Setting item	Description
Master 1 Attenuator	<p>Sets the attenuation level of the sound output from the [MASTER 1] terminals.</p> <ul style="list-style-type: none"> Setting values: -12dB, -6dB, 0dB*
Master/Booth Output	<p>Sets the output method ([Stereo] or [Mono]) for the sound output from the [MASTER] and [BOOTH/MASTER 2] terminals.</p> <ul style="list-style-type: none"> Setting values: Stereo*, Mono
Booth/Master 2 Attenuator	<p>Sets the attenuation level of the sound output from the [BOOTH/MASTER 2] terminals.</p> <ul style="list-style-type: none"> Setting values: -12dB, -6dB, 0dB*
Booth/Master 2 Setting	<p>Sets the sound output from [BOOTH/MASTER 2] terminals.</p> <ul style="list-style-type: none"> Setting values: Booth*, Master
Mic Output to Booth	<p>Determines whether or not to output the microphone sound to the [BOOTH] terminals.</p> <ul style="list-style-type: none"> Setting values: Off, On*
Mic Output to Master REC	<p>Determines whether or not to output the microphone sound to Master Rec (recording sound).</p> <ul style="list-style-type: none"> Setting values: Off, On*

Setting item	Description
Mic Output to USB Output	<p>Determines whether or not to output the microphone sound to the USB port (Type-C).</p> <ul style="list-style-type: none"> Setting values: Off, On*
Mixer Mode	<p>Sets the audio output when a PC is connected to the unit.</p> <ul style="list-style-type: none"> Setting values: OMNIS-DUO, MIDI Control*

❖ GENERAL

*: Factory setting

Setting item	Description
Language	Sets the display language.
Time Zone	<p>Sets the time zone.</p> <ul style="list-style-type: none"> Setting values: -12:00 to +14:00, ±0:00(UTC)*
Wi-Fi Frequency	<p>Sets the Wi-Fi frequency band.</p> <ul style="list-style-type: none"> Setting values: 5GHz (Recommended)*, 2.4GHz/5GHz We recommend 5 GHz band, which has stable communication. Before changing the setting, turn off Wi-Fi (page 122).
Font Size (Track List)	<p>Sets font size for the browse screen and Search screen.</p> <ul style="list-style-type: none"> Setting values: Normal*, Large
Screen Saver	<p>Sets the screen saver.</p> <ul style="list-style-type: none"> Setting values: Off, On* When set to [On], the screen saver starts if: <ul style="list-style-type: none"> You don't use the unit for more than 5 minutes when a track isn't loaded. You don't use the unit for more than 100 minutes during pause, during cue standby, or after playback reaches the end of a track. Use the unit to cancel the screen saver.

Setting item	Description
Power Management	Sets the Power Management function (page 112). <ul style="list-style-type: none"> Setting values: Never, 20min*
Default	Restores the settings to the factory settings. <ul style="list-style-type: none"> Setting values: Cancel*, Ok

❖ INFO

*: Factory setting

Setting item	Description
Version No.	Displays the version of the software on the unit.
Wi-Fi Address	Displays MAC address for the wireless LAN (Wi-Fi) connection.
Serial No.	Displays the serial number.
Battery Serial No.	Displays the serial number for the built-in battery.
License	Displays the license information of the unit.

Power Management

When [**Power Management**] is set to [**20min**], the unit automatically turns off after 20 minutes of inactivity if no audio signal is input to the unit.

- The factory setting is [**20min**].
- Set [**Power Management**] to [**Never**] if you don't need to use the Power Management function.
- Power consumption may increase when [**Power Management**] is set to [**Never**].

Changing the settings from the PORTABILITY screen

1 Touch the status display on the title/status bar.

The [PORTABILITY] screen appears.

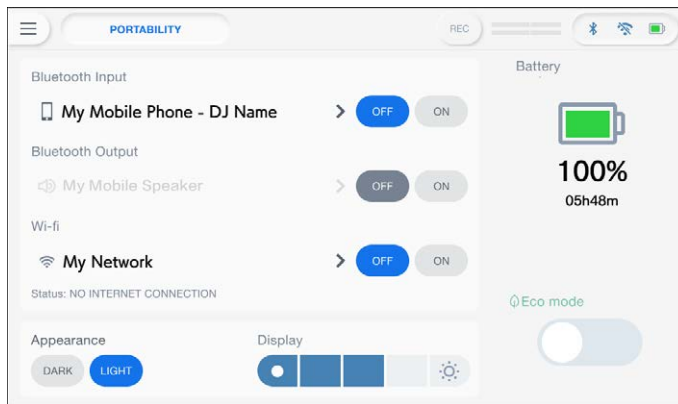

2 Select a setting value.

➡ Read more: PORTABILITY menu (page 114)

- Touch **X** on the title/status bar to close the [PORTABILITY] screen.

PORTABILITY menu

*: Factory setting

Setting item	Description
Bluetooth Input	<p>Sets whether to input sound from a mobile device, etc.</p> <ul style="list-style-type: none"> Setting values: OFF*, ON You can set [ON] for either [Bluetooth Input] or [Bluetooth Output].
Bluetooth Output	<p>Sets whether to output sound to a mobile device, etc.</p> <ul style="list-style-type: none"> Setting values: OFF*, ON You can set [ON] for either [Bluetooth Input] or [Bluetooth Output].
Wi-Fi	<p>Turns wireless LAN (Wi-Fi) on and off.</p> <ul style="list-style-type: none"> Setting values: OFF*, ON
Appearance	<p>Sets the dark mode or light mode for the display.</p> <ul style="list-style-type: none"> Setting values: DARK, LIGHT*
Display	<p>Sets the brightness of the LCD display.</p> <ul style="list-style-type: none"> Setting values: 1, 2, 3*, 4, 5
Battery indicator	<p>Displays the battery level and approximate remaining playable time.</p>
Eco mode	<p>Turn this on to limit the use of Bluetooth and wireless LAN (Wi-Fi) connections and to lower the brightness of the display to reduce power consumption.</p>

Calling up My Settings saved on a storage device (SD, USB)

You can call up My Settings from a storage device (SD, USB).

- You can call up My Settings from rekordbox connected in the PRO DJ LINK network or rekordbox CloudDirectPlay.

1 Connect a storage device (SD, USB) to the unit.

➔ Read more: Storage device connection (SD, USB) (page 41)

2 Touch [SOURCE] on the launcher screen.

The [SOURCE] screen appears.

3 Select a source.

4 Touch [MY SETTINGS LOAD] in the source information.

My Settings are called up.

- You can't call up My Settings when a track is playing. Pause the playback before calling up the settings.

Bluetooth[®]/MD connection

You can input the sound of your mobile device, etc. to the unit via Bluetooth or output sound from the unit to a mobile speaker, etc.

Bluetooth input section

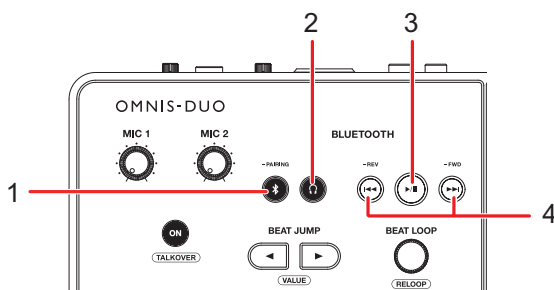

1. -PAIRING button

Press and hold to pair with a Bluetooth device.

2. button

Outputs the Bluetooth sound to headphones.



3. button

Plays or pauses the Bluetooth sound.

- This button may not be available for some Bluetooth devices.

4. buttons

Fastforwards or fastrewinds the Bluetooth sound.

- Press [] to jump to the beginning of the track that's playing. Press the button twice to jump to the beginning of the previous track.
- Press [] to jump to the beginning of the next track.
- This button may not be available for some Bluetooth devices.

Pairing with a Bluetooth device (Bluetooth input)

1 Touch the status display on the title/status bar.



The [PORTABILITY] screen appears.

2 Touch [ON] for [Bluetooth Input] to turn it on.

3 Touch > for [Bluetooth Input].

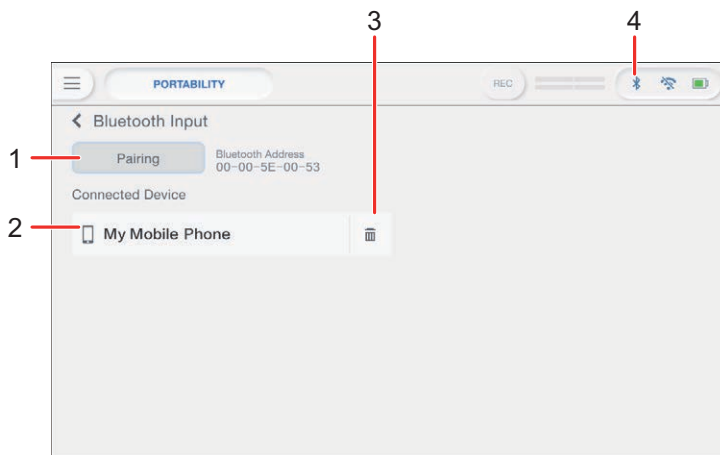
The [Bluetooth Input Setting] screen appears.



1. **Pairing**
2. **Name of the connected device**
3.  **(Remove device)**
4.  **(Bluetooth connection icon)**

4 Touch [Pairing].

The unit enters pairing state.

- The unit also enters pairing state if you press and hold the [-PAIRING] button.
- The Bluetooth icon blinks while the unit is in pairing state (for approximately 2 minutes).

5 Perform the pairing procedure on a Bluetooth device.

6 Allow the connection on the unit.

The Bluetooth indicator on the unit stops blinking and lights up when the connection is established.

- Perform the pairing procedure on a Bluetooth device while the unit is in pairing state. If the unit can't pair with a Bluetooth device within 2 minutes, the Bluetooth indicator turns gray.
- For details on the pairing procedure for the Bluetooth device, refer to the device's instruction manual.
- You can only connect the unit to one Bluetooth device at a time. If the unit pairs with a second device, the registration of the first device will be lost. To register the first device again, perform pairing with the device.
- Touch  to connect with other Bluetooth device than the registered one.

7 Select a Bluetooth device on the [SOURCE] screen and set [Send to] to [DECK] or [MIXER].

- When [Send to] is set to [DECK], you can DJ with the sound input from the connected Bluetooth device (page 119).
- When [Send to] is set to [MIXER], the Bluetooth sound is output from the selected channel.
- When [Send to] is set to [MIXER], [CH1] and [CH2] (channel to assign to) are displayed.
- The Bluetooth sound can be assigned to either of the channels.

DJing with the sound from a mobile device, etc. (Bluetooth Playback)

You can DJ with the sound input from a Bluetooth device.

1 Select a Bluetooth device on the [SOURCE] screen and set [Send to] to [DECK].

The playable range (up to 10 minutes) is displayed on the meter.

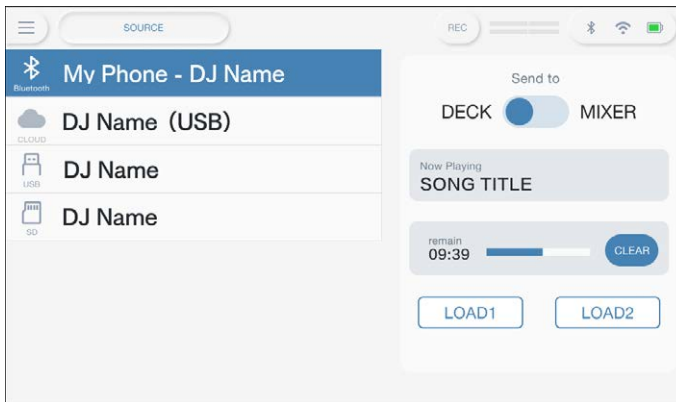

2 Touch [LOAD 1] or [LOAD 2].

You can DJ with the loaded sound on the selected deck.

- When [Send to] is set to [DECK], [LOAD 1] and [LOAD 2] (the decks to load to) are displayed.
- You can DJ with the Bluetooth sound loaded to either of the decks.
- Touch [Clear] to clear the DJ playable range.

3 Operate a Bluetooth device with the buttons in the Bluetooth input section on the unit.

- You can use the functions supported by the connected Bluetooth device.

Connecting to a mobile speaker, etc. (Bluetooth output)

1 Touch the status display on the title/status bar.



The [PORTABILITY] screen appears.

2 Touch [ON] for [Bluetooth Output] to turn it on.

3 Touch > for [Bluetooth Output].

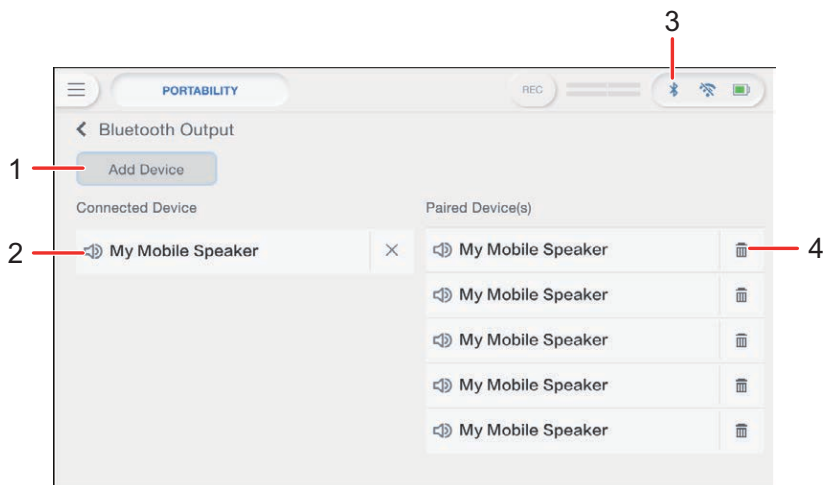
The [Bluetooth Output Setting] screen appears.



1. **Add Device button**
2. **Name of the connected device**
3.  **(Bluetooth connection icon)**
4.  **(Remove device)**

4 Touch [Add Device].

The unit enters pairing state.

- The Bluetooth indicator blinks while the unit is in pairing state (for approximately 1 minute).

5 Perform the pairing procedure on a Bluetooth device.

6 Allow the connection on the unit.

The Bluetooth indicator on the unit stops blinking and lights up when the connection is established.

- You may need to enter a passcode, etc., depending on the connected device. Follow the instructions on the screen to connect.
- Perform the pairing procedure on a Bluetooth device while the unit is in pairing state. If the unit can't pair with a Bluetooth device within 1 minute, the Bluetooth indicator turns gray.
- For details on the pairing procedure for the Bluetooth device, refer to the device's instruction manual.
- If you use a Bluetooth device registered to the unit, the unit automatically connects the device when Bluetooth is turned on.
- You can register 5 Bluetooth devices to the unit. If the unit pairs with a new device when 5 devices are already registered, the first registered device will be cleared. To register the device again, perform pairing with the device.
- Touch  to clear the registered device.

Wireless LAN (Wi-Fi®) connection

1 Touch the status display on the title/status bar.

The [PORTABILITY] screen appears.

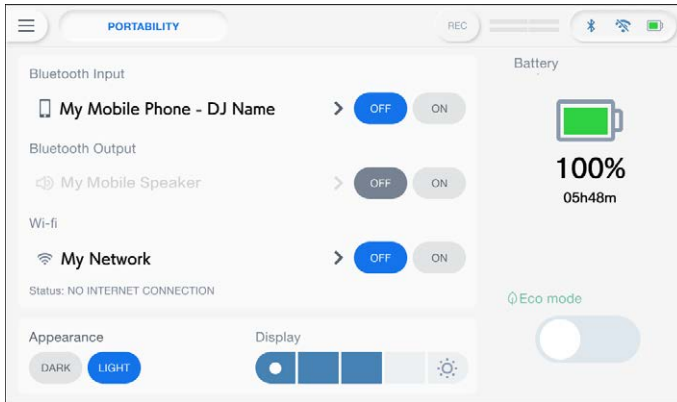

2 Touch [ON] for [Wi-Fi] to turn it on.

3 Touch > for [Wi-Fi].

The unit searches the network and available SSIDs are listed.

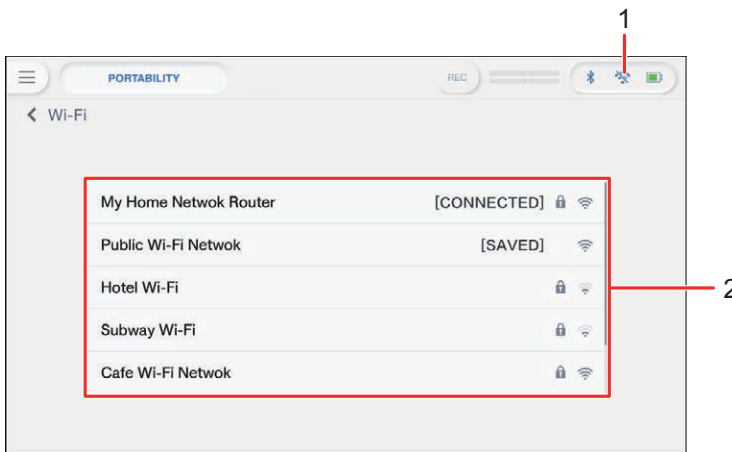

1.  (Wi-Fi connection icon)
2. **SSID list**

4 Touch the network (SSID) you want to use.

Wireless LAN (Wi-Fi®) connection

The password input screen appears.

5 Enter a password and touch [CONNECT].

If the connection succeeds, [CONNECTED] is displayed in the network name (SSID) field and it's displayed at the top of the list.

- You don't need to do this if you're using an access point that's connected to the unit previously.
- Touch the network (SSID) you're using to view its information on the network information screen. If you turn on [AUTO-CONNECT] on the network information screen, the unit automatically connects to the access point the next time you use it.
- To delete the networks (SSID) saved to the unit, touch [SAVED NETWORKS] at the bottom of the list. Select the networks (SSID) to delete in the list and touch [FORGET THIS NETWORK] on the network information screen.
- To connect to the stealth network manually, touch [MANUAL INPUT] listed last on the SSID list screen. If you enter the network name (SSID) to connect to, the connection will start.

Checking the internet connection

You can check the internet connection status on the [PORTABILITY] screen.

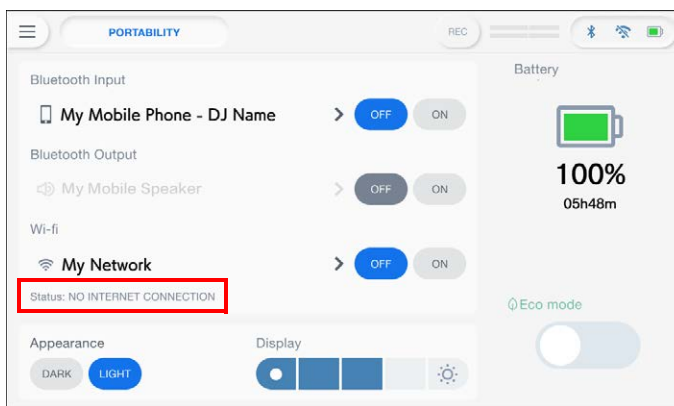

- The unit isn't connected to the internet when [NO INTERNET CONNECTION] is displayed. If this is the case, check the internet connection.

Using DJ software

If you connect the unit to a PC/Mac with MIDI software installed, via a USB cable, you can use the unit to control DJ software.

- To play tracks stored on a PC (Windows) with the unit, install the dedicated audio driver software (page 20). If you use a Mac, you don't need to install the dedicated audio driver software.
- For details on the unit's MIDI messages, visit the URL below.

alphatheta.com/support/

- Install DJ software and configure the audio and MIDI settings on a PC/Mac beforehand.
- If you use rekordbox, you don't need to configure MIDI settings.
- It's recommended to connect this unit and a PC/Mac directly with a USB cable. When using a USB hub, use a product recommended by the manufacturer of your PC/Mac. We don't guarantee the operation of all USB hubs.

Controlling DJ software

1 Connect a PC/Mac to the unit.

➡ Read more: Rear panel (page 27)

2 Touch [SOURCE] on the launcher screen.

The [SOURCE] screen appears.

3 Select [SOFTWARE CONTROL].

The [SOFTWARE CONTROL] screen appears.

4 Press the [LOAD 1] or [LOAD 2] button.

The deck on which you press the button switches to control mode.

5 Launch the DJ software.

The unit starts communication with the DJ software.

Using DJ software

- Some buttons on the unit can't be used for controlling a DJ application.
- Control mode turns off when a track is loaded to the unit from a device other than the currently communicating device that's running the DJ software.

Specifications

AC adapter

Power requirements	AC 100 V – 240 V, 50 Hz/60 Hz
Rated current	1.2 A
Rated output	DC 5 V/3.0 A, DC 9 V/3.0 A, DC 12 V/3.0 A, DC 15 V/3.0 A, DC 20 V/2.25 A

General – Main Unit

Rated voltage, current	DC 5 V/3.0 A, DC 9 V/3.0 A, DC 15 V/3.0 A, DC 20 V/3.0 A
Power consumption (off)	0.3 W
Main unit weight	4.6 kg/10.1 lbs.
Max. external dimensions	(W × D × H) 500 × 307 × 71 mm/19.7" x 12.1" x 2.8"
Tolerable operating temperature	+5 °C – +35 °C (+41 °F – +95 °F)
Tolerable operating humidity	5 % – 85 % (no condensation)

Battery Section

Capacity	47.52 Wh (Built-in rechargeable lithium-ion battery)
Play time	Approximately 5 hours* ¹
Charge time	Approximately 3 hours (+25 °C (+77 °F))* ²
Recommended charging temperature	+10 °C – +35 °C (+50 °F – +95 °F)* ³

*1 It varies depending on usage conditions and the state of the built-in rechargeable battery.

*2 Charging time with the included AC Adapter. Time required to fully charge from an empty state. Charging time may vary depending on the conditions of use.

*3 It may take some time to start charging depending on usage conditions.

Audio Section

Sampling rate	44.1 kHz
A/D, D/A converters	24bit
Frequency characteristic	
USB, SD, MIC 1, MIC 2	20 Hz – 20 kHz
S/N ratio (rated output, A-WEIGHTED)	
USB, SD	112 dB
MIC	82 dB
Total harmonic distortion (20 Hz – 20 kHz BW)	
USB	0.003 %
Standard input level/Input impedance	
MIC	-57 dBu / 3.3 kΩ

Specifications

Standard output level/Load impedance/Output impedance

MASTER 1	+6 dBu/10 k Ω /390 Ω or less
MASTER 2/BOOTH	+2 dBu/10 k Ω /390 Ω or less
PHONES	+8 dBu/32 Ω /2 Ω or less

Rated output level/Load impedance

MASTER 1	+25 dBu/10 k Ω
MASTER 2	+21 dBu/10 k Ω

Channel equalizer characteristic

HI.....	-26 dB – +6 dB (20 kHz)
MID.....	-26 dB – +6 dB (1 kHz)
LOW	-26 dB – +6 dB (20 Hz)

Microphone equalizer characteristic

HI.....	-12 dB – +12 dB (10 kHz)
LOW	-12 dB – +12 dB (100 Hz)

Input/Output terminals

MIC input terminals

XLR connector & 1/4" TRS jack	1 set
1/4" TRS jack	1 set

MASTER 1 output terminal

XLR connector	1 set
---------------------	-------

MASTER 2/BOOTH output terminal

RCA pin jacks	1 set
---------------------	-------

PHONES output terminal

1/4" stereo jack	1 set
3.5 mm stereo mini jack	1 set

USB terminals

USB Type-A.....	1 set
	Power supply...5 V/1 A or less
USB Type-C	1 set
	Power Input...USB PD 45 W
USB Type-C	1 set

SD card slot

File system	Conforming to SD/SDHC/SDXC standards
Max. memory capacity	2 TB

Wireless LAN section

Supported standards.....	IEEE 802.11 a/b/g/n/ac
Frequency band used	2.4 GHz/5 GHz

Bluetooth®/MD section

Wireless system..... Bluetooth Ver.5.2
Maximum transmission distance..... Approximately 20 m* in unobstructed circumstances.
Frequency band used2.4 GHz
Compatible Codecs..... SBC, AAC
* Transmission distances are a guideline. Transmission distance may change depending on the surrounding environment.

Specifications of external power supply (for European Union customers)

Manufacturer's nameALPHATHETA EMEA LIMITED
Commercial registration number.....09230173
Address..... Unit 39, Tileyard Studios, Tileyard Road, London, N7 9AH, U.K.
Model identifier..... FSP045-A2CR3
Input voltage AC 100 V to 240 V
Input AC frequency 50 Hz / 60 Hz
Output voltage..... DC 5.0 / 9.0 / 12.0 / 15.0 / 20.0 V
Output current 3.0 / 3.0 / 3.0 / 3.0 / 2.25 A
Output power 15.0 / 27.0 / 36.0 / 45.0 / 45.0 W
Average active efficiency89.4 %
Efficiency at low load (10 %).....76.3 %
No-load power consumption 0.06 W

Information requirements of the European Ecodesign Directive

English

The specifications and design of this product are subject to change without notice.
This product is not guaranteed to be able to connect to all devices equipped with wireless LAN or Bluetooth functions.

Additional information

Troubleshooting

If you think something is wrong with the unit, check the information below and refer to the [FAQ] for the OMNIS-DUO at the URL below.

alphatheta.com/support/

- Inspect devices connected to the unit.
- The unit may work normally if you turn the power off and on.
- Press the power button for more than 15 seconds to forcibly turn the power off. If you forcibly turn the power off, the device's management data may be deleted or the storage device (SD, USB) may not be able to be read.

If the problems continue, read the Precautions for Use and consult an authorized service company or your dealer.

Error display

❖ E-8302 (Error type: CANNOT PLAY TRACK)

- The unit can't read audio files from the storage device. The audio files may be corrupted. Check if the files can be played with another player that supports files in the formats supported by this unit.

❖ E-8304/E-8305 (Error type: UNSUPPORTED FILE FORMAT)

- The loaded audio file is in a format that isn't supported by this unit. Play an audio file in a format that's supported by this unit (page 14).

Wireless LAN (Wi-Fi)

❖ The unit can't connect to the wireless LAN router (access point).

- Check if the network (SSID), password, and encryption method are set correctly. Match the settings on this unit with the network settings.

❖ The wireless LAN router (access point) can't be found.

- If the unit and the wireless LAN router (access point) are placed far apart, bring them closer together.
- If there is an obstacle between this unit and the wireless LAN router (access point), remove it.

Bluetooth

❖ The unit can't connect with a Bluetooth device.

- Turn on the unit and the Bluetooth device again, and perform the pairing procedure.

❖ Sound is interrupted.

- If the unit and the Bluetooth device is placed far apart, bring them closer together.
- If there is an obstacle between this unit and the Bluetooth device, remove it.
- Radio waves may interfere when using a Bluetooth connection and the wireless LAN (Wi-Fi) connection at the same time. Turn off the wireless LAN (Wi-Fi) function or set **[Wi-Fi Frequency]** to **[5GHz (Recommended)]** in the Utility settings.

rekordbox CloudDirectPlay

❖ Tracks aren't displayed or can't be loaded.

- Tracks aren't displayed on the browse screen if rekordbox for Mac/Windows or rekordbox for iOS/Android and the library in the cloud haven't been synchronized. Use the unit after the synchronization completes.
- Tracks aren't uploaded to Dropbox. Only tracks uploaded to Dropbox are displayed on the browse screen. If the upload hasn't completed, you can't load the tracks. Upload the tracks you want to use to Dropbox beforehand using rekordbox for Mac/Windows or rekordbox for iOS/Android.
- You can't load tracks to the unit when Dropbox is under maintenance or failure occurs in Dropbox. Use after the maintenance completes or after the issue is fixed. You can check the maintenance and failure status at the Dropbox website below.

<https://status.dropbox.com/>

❖ **The capacity of the storage device (SD, USB) is insufficient.**

- When using rekordbox CloudDirectPlay, tracks loaded from Dropbox are automatically saved temporarily on a storage device (SD, USB). It's recommended to use a storage device (SD, USB) with 1 GB or more of free space.

Storage device (SD, USB)

❖ **The playlist isn't displayed or the "rekordbox Device Library Plus not found!" error message is displayed.**

- Make sure that the storage device (SD, USB) has been converted to the Device Library Plus format (page 17).
- This unit only supports the Device Library Plus format.

LCD display

- Small black or shining points may appear on the LCD display. This is a phenomenon inherent to LCD displays and not a malfunction.
- When using the unit in cold places, the LCD display may be dark for a while after the power is turned on. Normal brightness will restore after a while.
- When the LCD display is exposed to direct sunlight, the light will reflect off it, making it difficult to see. Block the direct sunlight to improve visibility of the display.

Cleaning

Wipe with a dry soft cloth.

- Do not use organic solvents, acids or alkalis for cleaning.

Touch screen

- Operate the touch screen with your fingertip. Do not press it with excessive force.
- Do not operate the touch screen with hard and sharp-pointed objects such as a ballpoint pen, mechanical pencil, or sharp fingernail.

Battery

Cautions on battery charge

❖ Built-in battery

- If you don't use the battery for a long time, charge it up to approximately 50% once every 6 months to prevent deterioration.
- It may take a long time to charge the battery if it hasn't been used for a long time.
- The unit may not turn on when the battery level is low, even if you press the power button. If this is the case, connect the AC adapter (power cord) to the unit and charge the battery at least partially.
- Even if the AC adapter (power cord) is connected to the unit, if you press the power button when the battery level is low, the power button lights for 10 seconds and the unit doesn't turn on. Charge the battery at least partially, then turn the unit on.
- Even if the battery level isn't low, the power button will blink when there is a problem with the main unit. Read the Precautions for Use and consult an authorized service company or your dealer.
- Even if the AC adapter (power cord) is connected, the battery charge indicator blinks if the battery can't be charged due to usage conditions or the environment you're using it in. If the problem continues even if you use the battery within the recommended charging temperature range, read the Precautions for Use and consult an authorized service company or your dealer.
- Batteries have a limited lifespan. Capacity of the rechargeable battery gradually decreases as the battery is charged and used repeatedly. If the usable time of the battery becomes extremely short even if the battery has been fully charged, it's considered that the battery has reached the end of its life. Read the Precautions for Use and consult an authorized service company or your dealer.
- Battery life will vary depending on the conditions of storage, usage, and the environment the unit is in.

❖ Safety precautions

- Observe the following precautions to avoid serious injury or blindness due to liquid leakage, rupture, heat generation, or fire.
 - This unit has a built-in rechargeable lithium-ion battery.
If you insert the USB plug or power plug when it's wet, it may cause a short circuit due to liquids (tap water, seawater, soft drinks, etc.) or foreign objects adhering to the main unit or charging cable. It may cause abnormal heating or malfunction. Never insert the USB plug or power plug when the main unit or charging cable is wet.

Trademarks and registered trademarks

- rekordbox™ is a trademark or registered trademark of AlphaTheta Corporation.
- PRO DJ LINK™ is a trademark or registered trademark of AlphaTheta Corporation.
- Mac, macOS, iPadOS and Finder are trademarks of Apple Inc., registered in the U.S. and other countries and regions.
- Windows is a trademark or registered trademark of Microsoft Corporation in the U.S. and other countries.
- ASIO is a trademark or registered trademark of Steinberg Media Technologies GmbH.
- iOS is a trademark containing Cisco trademark signs in the U.S. and other countries.
- Android is a trademark of Google LLC.
- SD logo is a trademark of SD-3C, LLC.



- SDHC logo is a trademark of SD-3C, LLC.



- SDXC logo is a trademark of SD-3C, LLC.



- Dropbox is a trademark or registered trademark of Dropbox, Inc.
- Wi-Fi is a registered trademark of Wi-Fi Alliance®.
- The Bluetooth®/MD word mark and logos are registered trademarks owned by Bluetooth SIG, Inc. and any use of such marks by AlphaTheta Corporation is under license. Other trademarks and trade names are those of their respective owners.

Other product, technology and company names, etc. mentioned herein are trademarks or registered trademarks of their respective owners.

About using MP3 files

This product has been licensed for nonprofit use. This product has not been licensed for commercial purposes (for profit-making use), such as broadcasting (terrestrial, satellite, cable or other types of broadcasting), streaming on the Internet, Intranet (a corporate network) or other types of networks or distributing of electronic information (online digital music distribution service). You need to acquire the corresponding licenses for such uses. For details, see <http://www.mp3licensing.com>.

Cautions on copyrights

rekordbox restricts playback and duplication of copyright-protected music contents.

- When coded data, etc., for protecting the copyright is embedded in the music contents, it may not be possible to operate the program normally.
- When rekordbox detects that coded data, etc., for protecting the copyright is embedded in the music contents, processing (playback, reading, etc.) may stop.

Recordings you have made are for your personal enjoyment and according to copyright laws may not be used without the consent of the copyright holder.

- Music recorded from CDs, etc., is protected by the copyright laws of individual countries and by international treaties. It is the full responsibility of the person who has recorded the music to ensure that it is used legally.
- When handling music downloaded from the Internet, etc., it is the full responsibility of the person who has downloaded the music to ensure that it is used in accordance with the contract concluded with the download site.

The specifications and design of this product are subject to change without notice.

© 2023 AlphaTheta Corporation. All rights reserved.

<DRI1882-A>