

# Instruction Manual

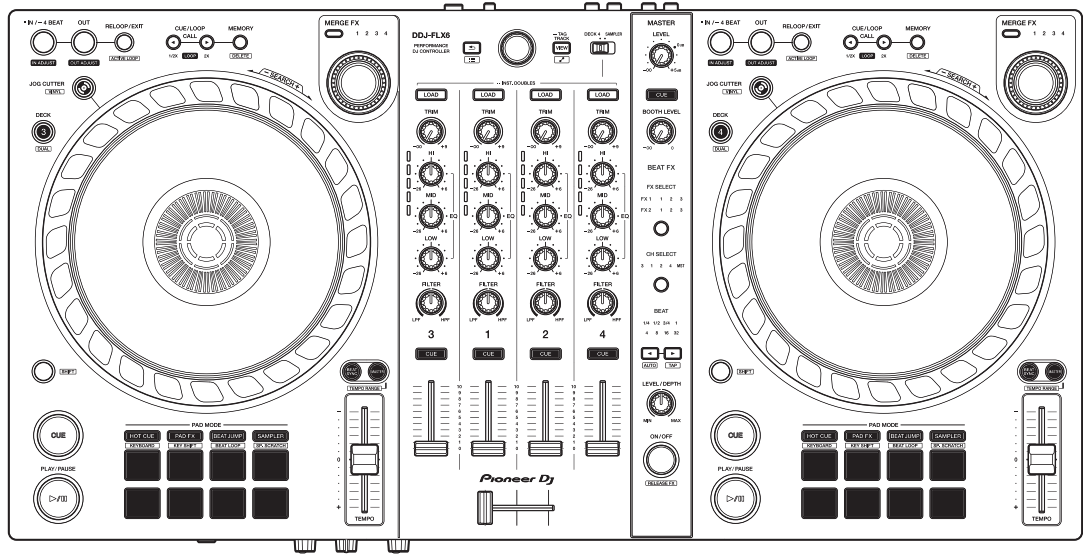

DJ Controller

# DDJ-FLX6

[pioneerdj.com/support/](http://pioneerdj.com/support/)

[rekordbox.com](http://rekordbox.com)

[serato.com](http://serato.com)

For FAQ and other support information for this product, visit the websites above.

**Pioneer Dj**

**serato**

---

## How to read this manual

Thank you for choosing this Pioneer DJ product.

Be sure to read this manual, the “Quick Start Guide” and the “Precautions for use” which are included with this product. These documents include important information that you should understand before using the unit. In particular, be sure to read the **IMPORTANT SAFETY INSTRUCTIONS**.

- In this manual, the names of buttons, knobs, and terminals that appear on the product, and the names of buttons, menus, etc. in the software on your PC/Mac or mobile device, are indicated within square brackets ([ ]). (e.g. **[File]**, **[CUE]** button)
- Please note that the software screens and their specifications, as well as the external appearance and specifications of the hardware, are subject to change without notice.
- Please note that depending on the operating system version, web browser settings, etc. operation may differ from the ways described in this manual.
- Please note that the language on the screens of the software described in this manual may differ from the language on your screen.

---

---

# Contents

How to read this manual .....	2
<b>Before you start.....</b>	<b>5</b>
What's in the box .....	5
User guides.....	5
DJ software.....	6
<b>Part names and functions .....</b>	<b>8</b>
Top panel.....	8
Browser section .....	9
Deck section .....	12
Mixer section.....	21
Effects section .....	23
Rear panel .....	25
Front panel.....	26
<b>Connections.....</b>	<b>27</b>
Connection examples .....	28
<b>rekordbox.....</b>	<b>31</b>
Installing rekordbox.....	31
Basic use .....	34
Advanced use .....	40
Changing the settings in rekordbox .....	68
<b>Serato DJ Pro.....</b>	<b>70</b>
Installing Serato DJ Pro .....	70
Activating FX Pack and Pitch 'n Time DJ .....	73
Basic use .....	75
Advanced use .....	82

<b>Changing the settings</b> .....	<b>104</b>
Launching Utilities mode.....	104
Utilities mode settings.....	105
<b>Additional information</b> .....	<b>108</b>
Troubleshooting .....	108
Specifications.....	116
Using the unit as a controller for other DJ applications .....	118
Trademarks and registered trademarks.....	119
Software license notice.....	120
Cautions on copyrights .....	122



---

---

# Before you start

---

---

## What's in the box

- USB cable
- Warranty (for some regions)<sup>1</sup>
- Quick Start Guide
- Precautions for use
- Serato Pitch'n Time DJ voucher<sup>2</sup>
- Serato FX Pack voucher<sup>2</sup>

<sup>1</sup> Only products in Europe.

Products in North America and Japan include warranty information in the "Precautions for use."

<sup>2</sup> The voucher codes needed to activate functions can't be reissued. Keep them in a safe place to be sure you don't lose them.

---

---

## User guides

---

---

### rekordbox Introduction, Instruction Manual

Refer to the "rekordbox Introduction" to find out how to set up rekordbox, and see the "rekordbox Instruction Manual" to find out how to use rekordbox.

[rekordbox.com/manual](https://rekordbox.com/manual)

---

---

### Serato DJ Pro software manual

Visit the Serato DJ Pro website.

[serato.com/dj/pro/downloads](https://serato.com/dj/pro/downloads)

---

## DJ software

---

### rekordbox

- rekordbox is a complete DJ application you can use to manage your music and perform.
- Even if you don't have a paid subscription plan, you can use Performance mode by connecting this unit to your PC/Mac with rekordbox installed. This is called Hardware Unlock.
- You'll find details of the functions available via Hardware Unlock on the rekordbox website.  
[rekordbox.com](http://rekordbox.com)
- The rekordbox software is not included with the unit. Download the software from the URL below.  
[rekordbox.com](http://rekordbox.com)
- For information on the latest system requirements, compatibility, and supported operating systems of rekordbox, check **[System requirements]** under **[Support]** at [rekordbox.com](http://rekordbox.com).
- Operation isn't guaranteed on all PC/Mac models, even if the system requirements are met.
- Depending on power-saving settings and other conditions of the PC/Mac, the CPU and hard disk may not provide sufficient processing capabilities. For laptops in particular, make sure the PC/Mac is in the best condition to provide constant high-level performance when using rekordbox (for example by keeping the AC power connected).
- To use the internet, you need a separate contract with an internet service provider, which you may have to pay for.
- Operating system support always assumes you're using the latest point release for that version.

## Serato DJ Pro

Serato DJ Pro is DJ software from Serato Limited.

This unit unlocks the software, which you can download from the Serato website.

[serato.com/dj/pro/downloads](https://serato.com/dj/pro/downloads)

- For information on the latest system requirements, compatibility, and supported operating systems of Serato DJ Pro, visit the website below.

[serato.com/dj/pro/downloads](https://serato.com/dj/pro/downloads)

- Operation isn't guaranteed on all PC/Mac models, even if the system requirements are met.
- Depending on power-saving settings and other conditions of the PC/Mac, the CPU and hard disk may not provide sufficient processing capabilities. For laptops in particular, make sure the PC/Mac is in the best condition to provide constant high-level performance when using Serato DJ Pro (for example by keeping the AC power connected).

---

---

# Part names and functions

---

---

## Top panel

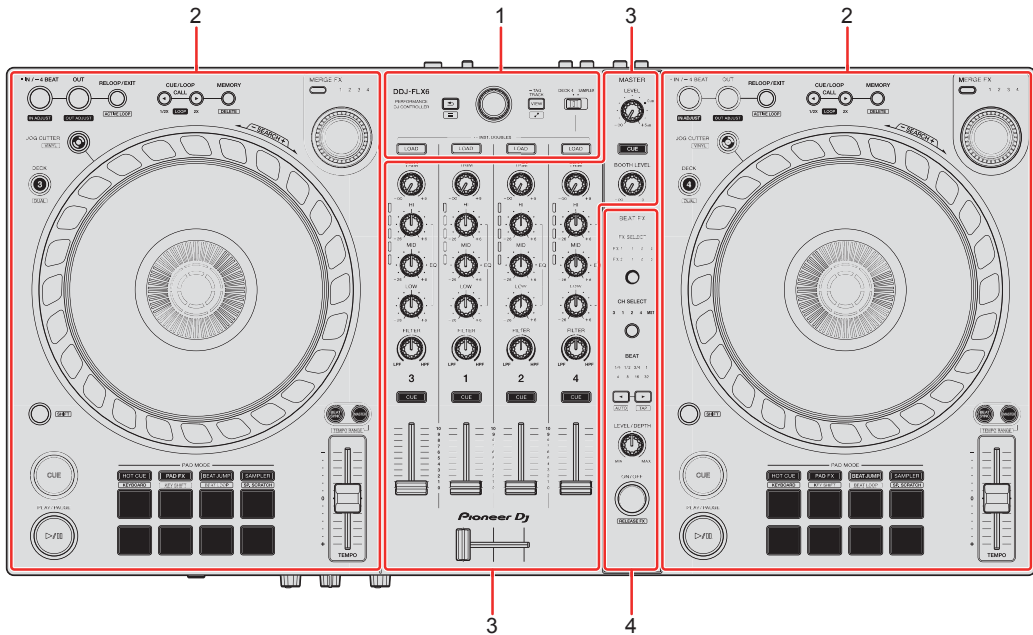

### 1 Browser section

Selects tracks and loads them to the decks.

### 2 Deck sections

Control each deck. There are knobs and buttons on the left side to control deck 1 and deck 3, and on the right side to control deck 2 and deck 4.

### 3 Mixer section

Controls the level adjustment for each channel, track mixing, etc.

### 4 Effects section

Controls the effect units.

## Browser section

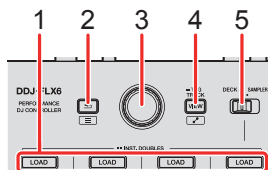

### 1 LOAD buttons

Press:

Load the selected track to the respective deck.

Press twice:

Load the track from the deck that isn't playing onto the deck that is playing. If you do this while the track is playing, it plays from the same position (Instant Doubles).

**[SHIFT]** + press:

Sort the track list in the library as follows, depending on the **[LOAD]** button you press:

Deck 1: Sorts by BPM.

Deck 2: Sorts by track title/song.

Deck 3: Sorts by keys.

Deck 4: Sorts by artist names.

### 2 ↶ (back) button

(rekordbox)

Press:

Moves the cursor between the tree view and track list each time you press the button.

- If the playlist palette is displayed, you can also move the cursor to the playlist.
- The tree view, track list, and playlist palette are displayed in the browse section of rekordbox. For details on each, read the “rekordbox Instruction Manual”.

# Part names and functions

**[SHIFT]** + press:

Displays/hides the playlist palette.

(Serato DJ Pro)

Press:

Moves the cursor between the library and **[crates]** panel each time you press the button.

**[SHIFT]** + press:

Changes the screen layout of Serato DJ Pro.

## 3 Rotary selector

(rekordbox)

Turn:

Moves the cursor in rekordbox.

**[SHIFT]** + turn:

Enlarges or shrinks the enlarged waveform in rekordbox.

Turn to the right to enlarge, or the left to shrink it.

Press:

Moves the cursor between the tree view and track list each time you press the button. If the cursor is pointed to a folder, the folder opens.

- If the playlist palette is displayed, you can also move the cursor to the playlist.
- The tree view, track list, and playlist palette are displayed in the browse section of rekordbox. For details on each, read the “rekordbox Instruction Manual”.

**[SHIFT]** + press:

Moves the cursor between the tree view and track list each time you press the button. If the cursor is pointed to a folder, the folder closes.

# Part names and functions

(Serato DJ Pro)

Turn:

Moves the cursor up or down in the library or in the **[crates]** panel.

Press:

Moves the cursor between the library and **[crates]** panel each time you press the button.

## 4 VIEW button

(rekordbox)

Press:

Shrinks the deck display and enlarges the browse area. Press the button again to return to the original display status.

Press for at least a second:

Registers or deletes the selected track to/from **[Tag List]**.

**[SHIFT]** + press:

Moves the cursor into **[Related Tracks]** in the tree view.

(Serato DJ Pro)

Press:

Changes the screen layout of Serato DJ Pro.

## 5 DECK4/SAMPLER selector switch

Selects whether channel 4 plays the sampler sound or the sound from deck 4.

## Deck section

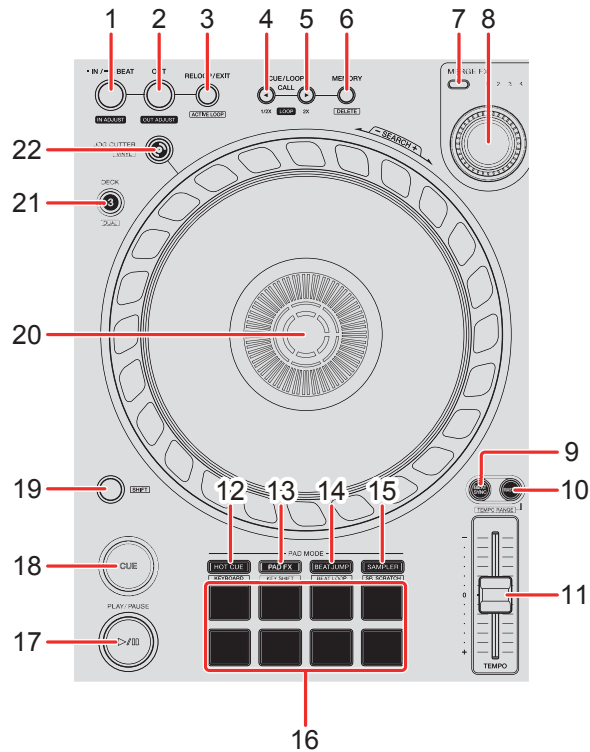

### 1 IN/4BEAT button

Press:

Sets the loop in point.

Press (during loop playback):

Adjusts the loop in point using the jog wheel.

Press for at least a second:

Starts Auto Beat Loop of 4 beats.

### 2 OUT button

Press:

Sets the loop out point, and loop playback begins.



# Part names and functions

Press (during loop playback):

Adjusts loop out point using the jog wheel.

## 3 RELOOP/EXIT button

Press:

Playback returns to the previously set loop in point and loop playback resumes.

Press (during loop playback):

Cancels loop playback.

(rekordbox)

**[SHIFT]** + press:

Switches the active/non-active status of the loop. (Active Loop)

- During playback, the loop nearest the playback position is set to active.
- When you call up the loop, the loop is set to active or non-active.

(Serato DJ Pro)

**[SHIFT]** + press:

Switches the active/non-active status of the loop.

## 4 CUE/LOOP CALL ◀ button

(rekordbox)

Press:

Selects and calls up the cue point or loop point.

Press (during loop playback):

Halves the loop playback length.

- When paused at the loop in point, the loop playback length isn't changed.

(Serato DJ Pro)

Press:

Selects the loop slot.

Press (during loop playback):

Halves the loop playback length.

## 5 CUE/LOOP CALL ► button

(rekordbox)

Press:

Selects and calls up the cue point or loop point.

Press (during loop playback):

Doubles the loop playback length.

- When paused at the loop in point, the loop playback length isn't changed.

(Serato DJ Pro)

Press:

Selects the loop slot.

Press (during loop playback):

Doubles the loop playback length.

## 6 CUE/LOOP MEMORY button

(rekordbox)

Press:

Saves a cue or loop.

**[SHIFT]** + press:

Deletes a cue or loop.

(Serato DJ Pro)

Press:

Locks the loop slot.

**[SHIFT]** + press:

Deletes the loop slot.

## 7 MERGE FX select button

Press:

Changes the Merge FX type, cycling through types in the following order:

Merge FX1, 2, 3, 4.

**[SHIFT]** + press:

Changes the Merge FX type, cycling through types in the reverse order.

## 8 MERGE FX knob

(rekordbox)

Press:

Turns the selected Merge FX on/off.

**[SHIFT]** + press:

Cancels Merge FX.

Turn:

The effect of the selected Merge FX changes.

**[SHIFT]** + turn:

Adjusts the volume of sample sound/oscillator sound of Merge FX.

(Serato DJ Pro)

Press:

Turns on the selected Merge FX.

Press while the selected Merge FX is turned on:

The effect changes.

To turn off the selected Merge FX, see “Using Merge FX” (page 97).

Turn:

The effect of the selected Merge FX changes.

## 9 BEAT SYNC button

(rekordbox)

Press:

Automatically synchronizes the tempo (BPM) and beatgrid with the deck set as the master.

Press (during Beat Sync):

Cancels Beat Sync.

(Serato DJ Pro)

Press:

The tempo (BPM) and beatgrid of multiple decks are automatically synchronized.

**[SHIFT]** + press:

Cancels Sync mode.

## 10 MASTER button

(rekordbox)

Press:

Sets the relevant deck as the master.

**[SHIFT]** + press:

Switches the range of the **[TEMPO]** slider each time the button is pressed while holding the **[SHIFT]** button.

Switch between **[±6%]** → **[±10%]** → **[±16%]** → **[WIDE]** → **[±6%]**.

(Serato DJ Pro)

Press:

Cancels Sync mode.

# Part names and functions

**[SHIFT]** + press:

Switches the range of the **[TEMPO]** slider each time the button is pressed while holding the **[SHIFT]** button.

Switch between **[±6%]** → **[±10%]** → **[±16%]** → **[±100%]** → **[±6%]**.

## 11 TEMPO slider

Adjusts the playing speed of the track.

## 12 HOT CUE mode button

Press:

Enters Hot Cue mode.

➡ Read more: Using Hot Cues (page 42)(page 84)

(rekordbox)

**[SHIFT]** + press:

Enters Keyboard mode.

➡ Read more: Using Keyboard mode (page 48)

(Serato DJ Pro)

**[SHIFT]** + press:

Enters Cue Loop mode.

➡ Read more: Using Cue Loop (page 87)

## 13 PAD FX mode button

(rekordbox)

Press:

Enters Pad FX mode.

➡ Read more: Using Pad FX (page 50)

**[SHIFT]** + press:

Enters Key Shift mode.

➡ Read more: Using Key Shift (page 52)

(Serato DJ Pro)

Press:

Enters Roll mode.

**[SHIFT]** + press:

Enters Saved Loop mode.

## 14 BEAT JUMP mode button

(rekordbox)

Press:

Enters Beat Jump mode.

➡ Read more: Using Beat Jump (page 44)

**[SHIFT]** + press:

Enters Beat Loop mode.

➡ Read more: Using Beat Loop (page 44)

(Serato DJ Pro)

Press:

Enters Auto Loop mode.

➡ Read more: Using Auto Loop (page 86)

**[SHIFT]** + press:

Enters Slicer Loop mode.

## 15 SAMPLER mode button

Press:

Enters Sampler mode.

➡ Read more: Using Sampler (page 46)(page 86)

(rekordbox)

**[SHIFT]** + press:

Enters Sample Scratch mode.

➡ Read more: Using Sample Scratch (page 53)

(Serato DJ Pro)

**[SHIFT]** + press:

Enters Scratch Bank mode.

➡ Read more: Using Scratch Bank mode (page 92)

## 16 Performance Pads

Press:

You can use Performance Pads to trigger various features.

➡ Read more: Using the Performance Pads (page 42)(page 84)

## 17 PLAY/PAUSE ►/⏸ button

Press:

Plays/pauses a track.

(Serato DJ Pro)

**[SHIFT]** + press:

Returns to the temporary cue point and playback starts. (Stutter)

## 18 CUE button

Press:

Sets, calls up, and plays a cue point.

- Press the button when the track is paused to set the cue point.
- Press the button when the track is playing to return to the cue point and pause. (Back Cue)
- Press the button and hold it after the track returns to the cue point and playback will continue until you release the button. (Cue Point Sampler)

**[SHIFT]** + press:

Returns the playback position to the beginning of the track.

## 19 SHIFT button

Press another button while holding the **[SHIFT]** button to use a different feature assigned to the button.

## 20 Jog wheel

Turn the top when Vinyl mode is on:  
Scratches the track.

Turn the outer section or turn the top when Vinyl mode is off:  
Bends the pitch (Pitch Bend – slows down or speeds up the track).

(rekordbox)

**[SHIFT]** + turn the top:

Fast-forward or fast-reverse the track with extra speed.

(Serato DJ Pro)

**[SHIFT]** + turn the top:

The playback position skips in sync with the beat. (Skip mode)

- Skip mode can't be used with tracks that have no beatgrid set. For details on setting beatgrids, see the Serato DJ Pro software manual.
- To use Skip mode, open the **[SETUP]** menu in Serato DJ Pro > **[SYNC PREFERENCES]** and select **[Smart Sync]**.

## 21 DECK SELECT button

Press:

Switches the deck to be used.

**[SHIFT]** + press:

Turns Dual Deck mode on/off.

## 22 JOG CUTTER button

Press:

Turns Jog Cutter mode on/off.

**[SHIFT]** + press:

Turns Vinyl mode on/off.



## Mixer section

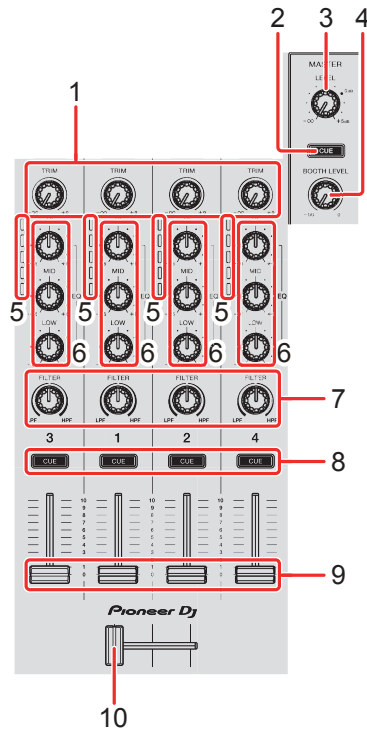

### 1 TRIM knobs

Adjust the volume of each channel's sound.

### 2 Headphone CUE button (master)

Press:

Plays the master sound through your headphones.

### 3 MASTER LEVEL knob

Adjusts the volume of the master output sound.

### 4 BOOTH LEVEL knob

Adjusts the volume of the sound output from the **[BOOTH]** terminal.

### 5 Channel level indicators

Indicate the volume of the sound of the respective channels before it passes through the channel faders.

# Part names and functions

## 6 EQ (HI, MID, LOW) knobs

Boost or reduce the relevant frequency for the selected channel.

## 7 FILTER knobs

Turn on the filter effect for each channel.

When a knob is set to the center position, the sound is unchanged.

Turn counterclockwise:

Gradually decreases the low-pass filter's cutoff frequency.

Turn clockwise:

Gradually increases the high-pass filter's cut-off frequency.

## 8 Headphone CUE buttons (channel)

Press:

Play the sound of the relevant channel through your headphones.

**[SHIFT]** + press:

Hold the **[SHIFT]** button and tap the headphone **[CUE]** button to set the tempo of the respective deck in time with your tapping. (Tapping function)

## 9 Channel faders

Adjust the volume of the sound for each channel.

## 10 Crossfader

Adjusts the sound balance between the left and right channels depending on the crossfader curve setting.

## Effects section

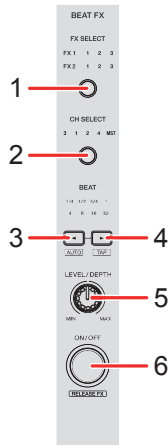

### 1 BEAT FX SELECT button

Press:

Changes the Beat FX slot each time the button is pressed.

[SHIFT] + press:

Changes the Beat FX slot in the reverse order each time the button is pressed.

### 2 BEAT FX CH SELECT button

Press:

Changes the channel each time the button is pressed.

[SHIFT] + press:

Changes the channel in the reverse order each time the button is pressed.

### 3 BEAT ◀ button

Press:

Decreases the beat fraction for synchronizing the Beat FX sound each time the button is pressed.

# Part names and functions

**[SHIFT]** + press:

Sets the Beat FX Tempo mode to BPM Auto mode. The track's BPM is used as the basis for the Beat FX tempo.

## 4 **BEAT ► button**

Press:

Increases the beat fraction for synchronizing the Beat FX sound each time the button is pressed.

**[SHIFT]** + press:

Sets the Beat FX Tempo mode to BPM Tap mode. The BPM used as the basis for Beat FX is set in time with your tapping of the button.

## 5 **BEAT FX LEVEL/DEPTH knob**

Adjusts the parameter of Beat FX.

## 6 **BEAT FX ON/OFF button**

Press:

Turns Beat FX on/off.

(rekordbox)

**[SHIFT]** + press:

Turns Release FX on/off.

## Rear panel

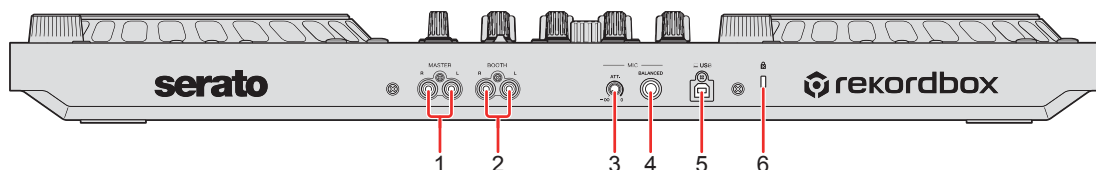

### 1 MASTER output terminals (RCA pin jack type)

Connection for a powered speaker, a power amplifier, etc.

- Compatible with RCA pin jack-type unbalanced outputs.

### 2 BOOTH output terminals (RCA pin jack type)

Connection for a powered speaker, a power amplifier, etc.

- Compatible with RCA pin jack-type unbalanced outputs.

### 3 MIC ATT. (Attenuator) knob

Adjusts the volume of input sound from the **[MIC]** input terminal.

- Depending on the microphone, the gain of microphone sound differs. Use this knob to adjust the volume for your microphone before using it. While DJing, use the **[MIC LEVEL]** knob on the front panel to adjust the microphone volume.

### 4 MIC input terminal (1/4" TRS Jack)

Connection for a microphone.

- Only a phone plug (1/4") can be used.

### 5 USB port

Connection for a PC/Mac.

- Be sure to use the supplied USB cable.
- A USB hub can't be used with the unit.
- If your PC/Mac has only a USB Type-C port, you'll need to use a USB Type-C male to USB Type-A female cable.

### 6 Kensington security slot

Connection for a cable lock for security.

## Front panel

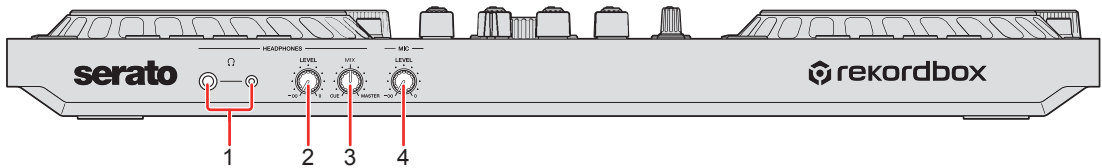

### 1 PHONES output terminals

Connection for your headphones.

Stereo phone plugs (1/4") and stereo mini phone plugs ( $\varnothing$  3.5 mm) can be used with the unit.

- Only use headphones with 32  $\Omega$  or more impedance. Headphones with impedance lower than 32  $\Omega$  won't work with the unit.

### 2 HEADPHONES LEVEL knob

Adjusts the level of the headphones sound.

### 3 HEADPHONES MIX knob

Adjusts the monitor volume balance between sounds from the channels which have the headphone **[CUE]** button pressed, and the master channel.

### 4 MIC LEVEL knob

Adjusts the level of sound input to the **[MIC]** input terminal.

---

---

# Connections

- Disconnect the USB cable before connecting different devices or changing connections.  
Refer to the instruction manuals for devices to be connected.
- Power is supplied via USB bus power. You can use the unit with a single connection to your PC/Mac.
- Be sure to use the supplied USB cable.
- A USB hub can't be used with the unit.
- This unit can't be used with USB bus power in the following situations:
  - The power supply capacity of the USB port on your PC/Mac is too low.
  - Your PC/Mac is connected with other devices.
  - Impedance of the connected headphones is lower than 32  $\Omega$ .
  - The **[PHONES]** output terminal is connected with a mono jack.

## Connection examples

### Connecting input terminals

#### Rear panel

- (1) & (2) Powered speakers, power amplifier, etc.,
- (3) Microphone, (4) PC/Mac

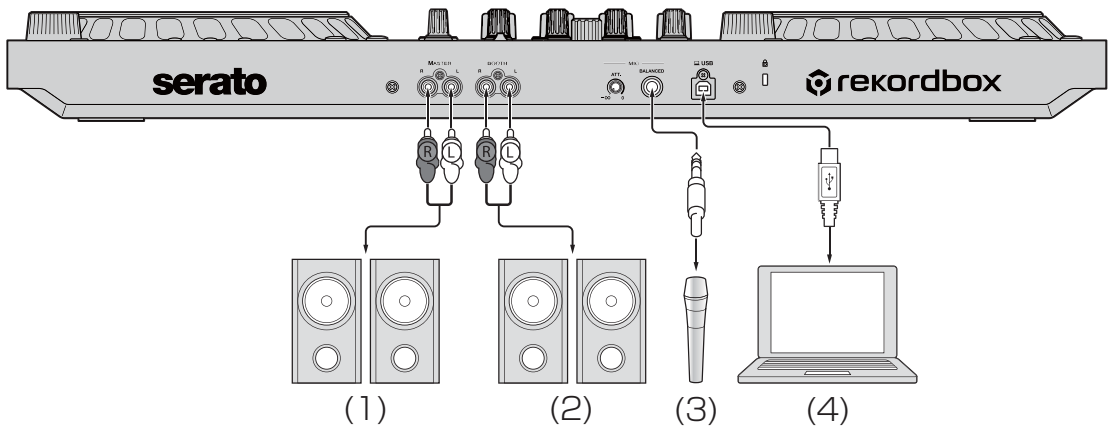

#### Front panel

- (1) Headphones

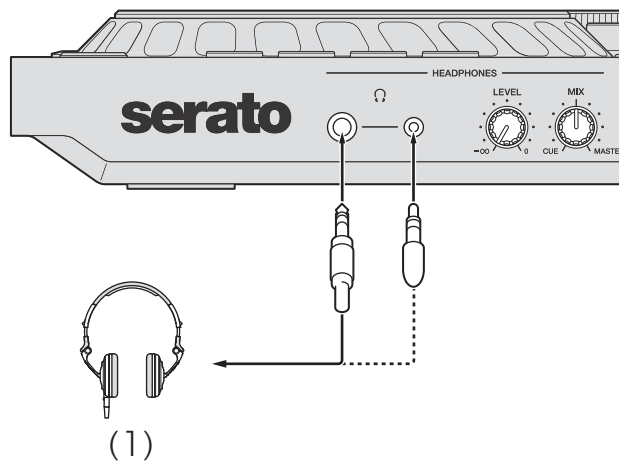



## Connecting

- 1 Connect your headphones to one of the **[PHONES]** output terminals.

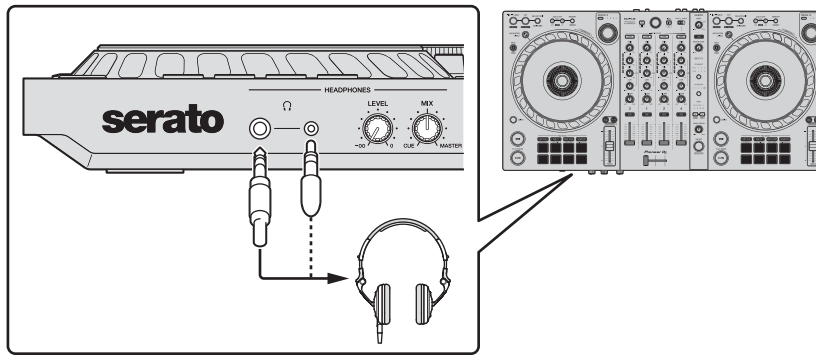

- Only connect headphones with 32  $\Omega$  or more impedance. Headphones with impedance lower than 32  $\Omega$  won't work with the unit.

- 2 Connect powered speakers, a power amplifier, etc. to the **[MASTER]** output terminals.

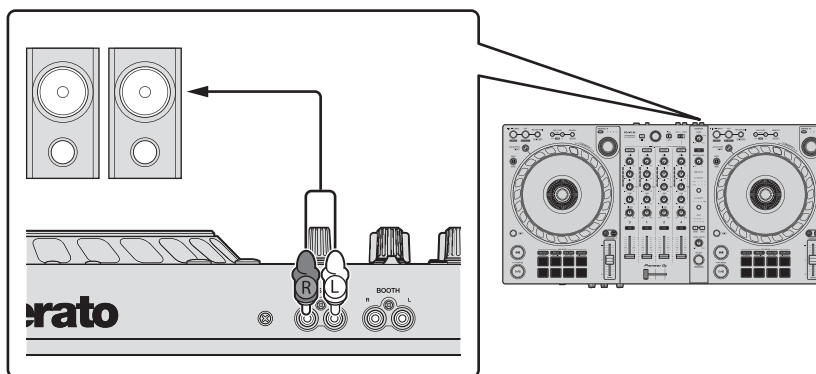

- To output the sound from the **[BOOTH]** output terminals, connect speakers or other devices to the **[BOOTH]** output terminals.

- 3 Connect the unit to your PC/Mac via a USB cable.

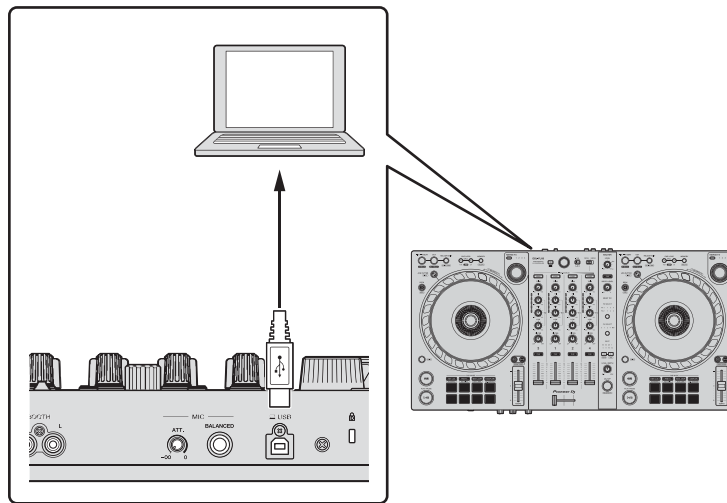

- 4 Turn on your PC/Mac.
- 5 Turn on the devices connected to the terminals (powered speakers, microphone, etc.).

---

---

# rekordbox

---

---

## Installing rekordbox

---

---

### Getting started with rekordbox

If you're using rekordbox for the first time, download the latest version from rekordbox.com and install it in the following way.

If you already have rekordbox installed, update to the latest version using the Update Manager which you'll see when you start rekordbox.

- You are responsible for preparing your PC/Mac, network devices, and other elements needed to connect to the internet.

---

---

### Installing rekordbox

Procedures may differ depending on the operating system (OS) of your PC/Mac.

#### ❖ Installing (Mac)

**Do not connect the unit to your Mac until installation is complete.**

- Close all programs on your Mac.
- 1 Unzip the downloaded rekordbox software file.
  - 2 Double-click the unzipped software file to launch the installer.

- 3 Read the terms of the License Agreement carefully and if you agree to them, click **[Agree]**.

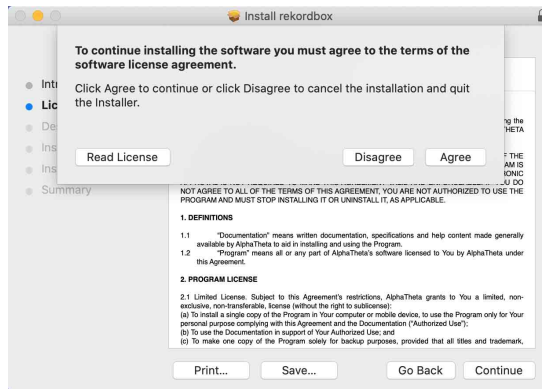

- If you do not agree to the contents of the License Agreement, click **[Disagree]** to cancel the installation.

- 4 When the screen for completing the installation appears, click **[Close]** to end the installation.

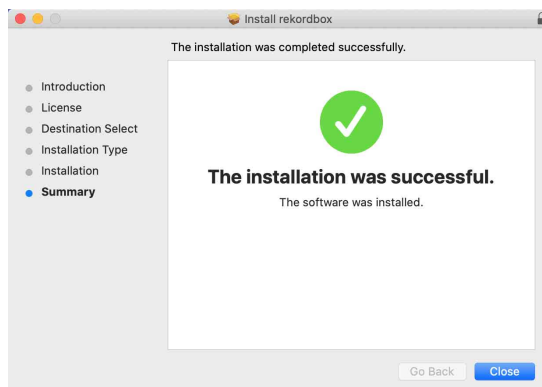

## ❖ Installing (Windows)

**Do not connect the unit to your PC until installation is complete.**

- Log into your PC as an administrator before starting the installation.
- Close all programs on your PC.

- 1 Unzip the downloaded rekordbox software file.
- 2 Double-click the unzipped software file to launch the installer.

- 3 Read the terms of the License Agreement carefully and if you agree to them, select **[Agree]**, then click **[Next]**.

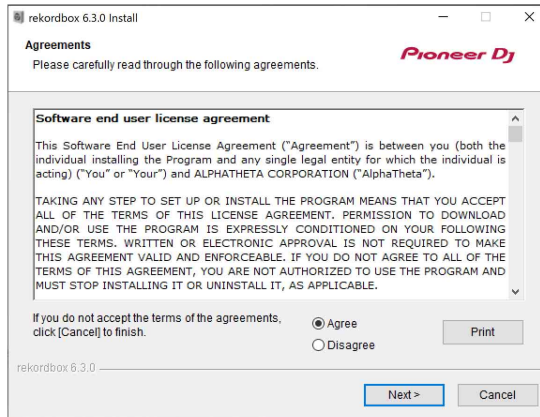

- If you do not agree to the contents of the license agreement, click **[Cancel]** to cancel the installation.
- After specifying the destination, the installation will start. When the installation is finished, a completion message will be displayed.

- 4 Click **[Finish]** to complete the installation.

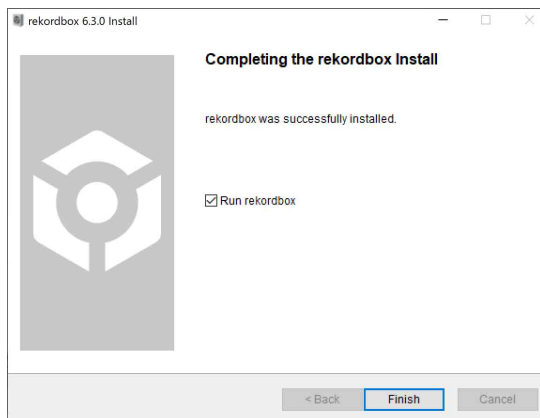

Installation is complete.

---

## Basic use

---

### Starting rekordbox

You need to register an account to use rekordbox.

#### For Mac

In Finder, open the **[Applications]** folder, then double-click the **[rekordbox 6] > [rekordbox.app]** icon.

#### For Windows 10

In the **[Start]** menu, click the **[rekordbox 6]** icon under **[Pioneer]**.

#### For Windows 8.1

In **[Apps view]**, click the **[rekordbox 6]** icon.

---

## Checking audio setup

Check that the **[Audio]** settings in **[Preferences]** in rekordbox are set as follows:

### For Mac

**[Audio]: [DDJ-FLX6]**

**[Output channels]:**

**[Master Output]: [DDJ-FLX6 : MASTER + audio device name on Mac]**

**[Headphones Output]: [DDJ-FLX6 : PHONES]**

- When PC MASTER OUT is off, **[Master Output]** in the **[Audio]** setting is **[DDJ-FLX6 : MASTER]**.

### For Windows

**[Audio]: [DDJ-FLX6 WASAPI]**

**[Output channels]:**

**[Master Output]: [DDJ-FLX6 WASAPI : MASTER + audio device name on PC]**

**[Headphones Output]: [DDJ-FLX6 WASAPI : PHONES]**

- When PC MASTER OUT is off, **[Master Output]** in the **[Audio]** setting is **[DDJ-FLX6 WASAPI : MASTER]**.
- PC Master Out is a function that can output the master sound of rekordbox from the speaker(s) of the connected PC/Mac. By default, PC Master Out is set to on.
- To cancel outputting the master sound of rekordbox from the speaker(s) of the connected PC/Mac, click  in the top-right area of the rekordbox screen so its light switches off.

---

## Adding music files into your Collection

The **[Collection]** screen contains a list of music files managed by rekordbox.

Add music files on your PC/Mac to your Collection so the software can analyze them and they can be used in rekordbox.

- 1 Click **[Collection]** on the tree view.  
A list of tracks in your **[Collection]** is displayed.
- 2 Open Finder (Mac) or Explorer (Windows) and drag music files, or folders containing music files, into the track list.  
Music files are added into the **[Collection]** and analysis of waveform information for the music files begins. Wait until analysis of all music files is complete.

---

## Loading an audio track onto a deck

The following explains how to load a track onto deck 1 as an example.

Turn the rotary selector to select a track in your **[Collection]** and press the **[LOAD]** button for deck 1 (second from the left).

The track loads onto deck 1.

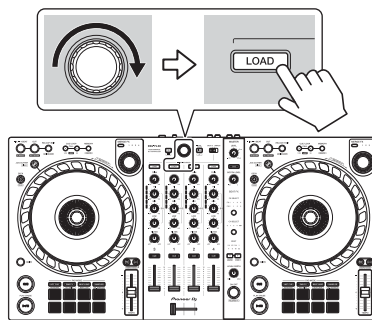



---

## Playing a track

This section explains how to play sound from deck 1 (left) as an example.

- 1 Set the positions of the knobs, etc. as follows:
  - **[TRIM]** knob: turned fully counterclockwise
  - **[EQ (HI/MID/LOW)]** knobs: center position (12 o'clock)
  - **[FILTER]** knob: center position
  - Channel fader: bottom position
  - **[MASTER LEVEL]** knob: turned fully counterclockwise
  - Crossfader: center position
- 2 Press the **[PLAY/PAUSE ▶/III]** button to play the track.

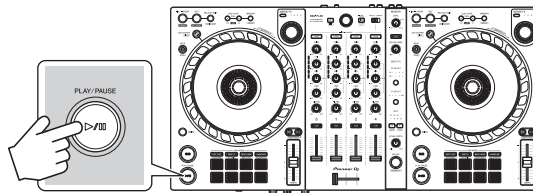

- 3 Turn the **[TRIM]** knob.  
Adjust the **[TRIM]** knob so the channel level indicator lights up orange at the loudest part of the track.

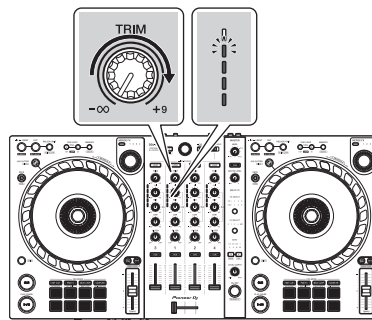

4 Move the channel fader to the top.

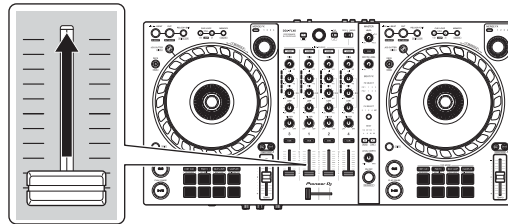

5 Turn the **[MASTER LEVEL]** knob to adjust the volume of the speakers to a level you're happy with.

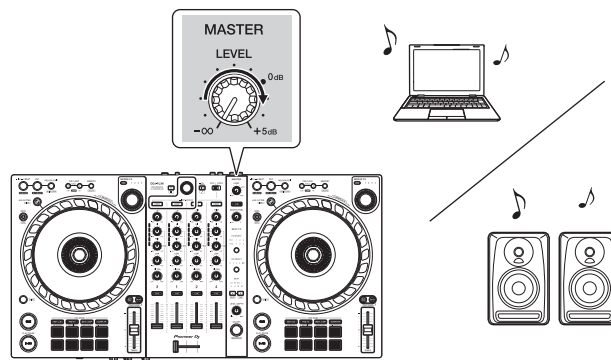

- If you're outputting sound from the speaker of your PC/Mac, adjust the speaker volume on the PC/Mac instead of using the **[MASTER LEVEL]** knob.
- If you can't output sound from the **[MASTER]** output terminals or the unit isn't recognized by your PC/Mac, refer to the **[FAQ]** on the Pioneer DJ support website.

[pioneerdj.com/support/](http://pioneerdj.com/support/)

---

## Monitoring with headphones

This section explains how to play sound from deck 1 (left) as an example.

- 1 Set the positions of knobs, etc. as shown below.
  - **[HEADPHONES MIX]** knob: Center
  - **[HEADPHONES LEVEL]** knob: Turned fully counterclockwise
- 2 Press the headphone **[CUE]** button for channel 1.
- 3 Turn the **[HEADPHONES LEVEL]** knob.  
Adjust the headphones volume to a level you're happy with.

---

## Quitting rekordbox

Click the **[x]** button or select **[Exit]** from the **[File]** menu.

---

## Turning off the unit

Disconnect the USB cable to turn off the unit.

---

## Advanced use

---

---

### Using 4 Beat Loop

While a track is playing, press and hold the **[IN/4BEAT]** button for at least a second.

Loop playback starts with 4 beats from the point where you press the button.

- When the Quantize function is turned on, you might notice a slight delay as the loop synchronizes to the beat.

#### ❖ Canceling loop playback

Press the **[RELOOP/EXIT]** button.

When the loop out point is reached, the rest of the track continues to play without returning to the loop in point.

---

### Using Manual Loop

You can use Manual Loop to choose the section you want to loop in a track.

- When the Quantize function is turned on, you might notice a slight delay as the loop synchronizes to the beat.
- 1 During playback, press the **[IN/4BEAT]** button at the point you want to start looping (the loop in point).
  - 2 Press the **[OUT]** button at the point you want the loop to end (the loop out point).  
Loop playback starts.

### ❖ Cutting the loop

Press the **[CUE/LOOP CALL ◀]** button.

Each time you press the button, the loop cuts in half.

- You can cut the loop length in half even during 4 Beat Loop playback.

### ❖ Extending the loop

Press the **[CUE/LOOP CALL ▶]** button.

Each time you press the button, the loop doubles in length.

- You can double the loop length even during 4 Beat Loop playback.

### ❖ Canceling a loop

Press the **[RELOOP/EXIT]** button.

The rest of the track continues to play without returning to the loop in point.

### ❖ Changing the loop in point

Press the **[IN/4BEAT]** button and turn the jog wheel during loop playback.

The loop in point changes.

### ❖ Changing the loop out point

Press the **[OUT]** button and turn the jog wheel during loop playback.

The loop out point changes.

---

## Using the Performance Pads

### ❖ Using Hot Cues

You can start playback instantly from the position where a Hot Cue is set. Loops can also be set and called up instantly.

- Up to 16 Hot Cues can be set and saved for each track in rekordbox. On the unit, up to 8 Hot Cues can be set and saved per track.

### Setting and calling up a Hot Cue

- 1 Press the **[HOT CUE]** mode button.

The unit enters Hot Cue mode.

- 2 If the track is playing or paused, press a Performance Pad to set a Hot Cue.

Hot Cues are set to Performance Pads as follows:

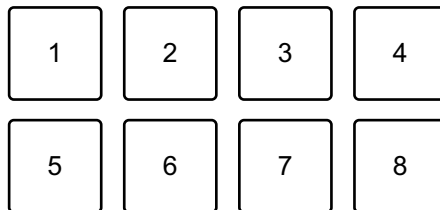

1: Hot Cue A, 2: Hot Cue B, 3: Hot Cue C, 4: Hot Cue D,  
5: Hot Cue E, 6: Hot Cue F, 7: Hot Cue G, 8: Hot Cue H

- 3 Press a Performance Pad you've set a Hot Cue for.

Playback starts from the Hot Cue point.

- You can clear Hot Cues by pressing a Performance Pad while holding the **[SHIFT]** button.

## Setting and calling up 4 Beat Loop

- 1 Press the **[HOT CUE]** mode button.  
The unit enters Hot Cue mode.
- 2 Press and hold the **[IN/4BEAT]** button for at least a second during playback.  
A loop with 4 beats is set at the position where you pressed the button, and loop playback starts.
- 3 Press a Performance Pad to set a loop during loop playback.
- 4 Press the Performance Pad.  
Loop playback starts from the loop in point.
  - You can clear the loop by pressing the Performance Pad while holding the **[SHIFT]** button.

## Setting and calling up Manual Loop

- 1 Press the **[HOT CUE]** mode button.  
The unit enters Hot Cue mode.
- 2 Press the **[IN/4BEAT]** button during playback, and press the **[OUT]** button.  
Loop playback starts.
- 3 Press a Performance Pad to set a loop during the loop playback.
- 4 Press the Performance Pad.  
Loop playback starts from the loop in point.
  - You can clear the loop by pressing the Performance Pad while holding the **[SHIFT]** button.

## ❖ Using Beat Loop

If you press a Performance Pad, a loop with the number of beats assigned to the pad is set. The loop keeps playing after you remove your finger from the pad.

- 1 Press the **[BEAT JUMP]** mode button while holding the **[SHIFT]** button.

The unit enters Beat Loop mode.

The number of beats set to the Performance Pads are as follows:

1	2	3	4
5	6	7	8

1: Beat Loop 1/4 beat, 2: Beat Loop 1/2 beat, 3: Beat Loop 1 beat,  
 4: Beat Loop 2 beats, 5: Beat Loop 4 beats, 6: Beat Loop 8 beats,  
 7: Beat Loop 16 beats, 8: Beat Loop 32 beats

- 2 Press a Performance Pad.

The loop plays with the number of beats set on that pad.

- 3 Press the same Performance Pad again.

The loop is canceled and the rest of the track continues to play.

## ❖ Using Beat Jump

You can move the playback position instantly, without breaking the rhythm of the track that's playing.

- 1 Press the **[BEAT JUMP]** mode button.

The unit enters Beat Jump mode.



The number of beats set to the Performance Pads are as follows (Default):

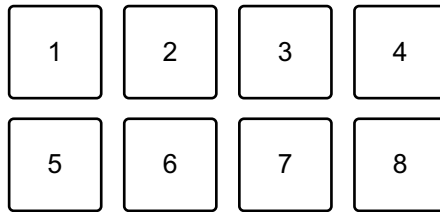

1: 1 beat (left direction), 2: 1 beat (right direction), 3: 2 beats (left direction),  
 4: 2 beats (right direction), 5: 4 beats (left direction), 6: 4 beats (right direction),  
 7: 8 beats (left direction), 8: 8 beats (right direction)

## 2 Press Performance Pad 7 or 8 while holding the **[SHIFT]** button to change the number of beats set to the Performance Pad.

When pressing Performance Pad 7 while holding the **[SHIFT]** button, the number of beats decreases.

When pressing Performance Pad 8 while holding the **[SHIFT]** button, the number of beats increases.

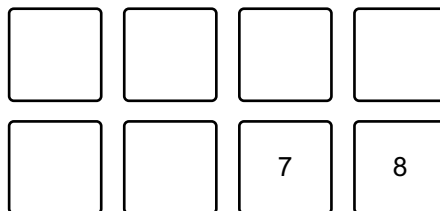

7: Number of beats goes down, 8: Number of beats goes up

## 3 Press a Performance Pad.

- Pad 1, 3, 5 or 7: The playback position is moved to the left by the number of beats set on the pad.
- Pad 2, 4, 6 or 8: The playback position is moved to the right by the number of beats set on the pad.

## ❖ Using Sampler

You can use the Performance Pads to play tracks or sounds assigned to the Sampler slots.

### Preparing to use Sampler

Click the  button at the top-left of the rekordbox screen to display the **[SAMPLER]** panel.

### Loading a track into a Sampler slot

- 1 Press the **[SAMPLER]** mode button.  
The unit enters Sampler mode.
- 2 Click the button at the right of **[BANK]** on the **[SAMPLER]** panel in rekordbox to change the Sampler bank.



In rekordbox, the sampler has 4 banks, and each bank has 16 slots.

- 3 Press the rotary selector to move the cursor to the track list.
- 4 Turn the rotary selector.  
Select a track you want to load into a Sampler slot.
- 5 Press a Performance Pad while holding the **[SHIFT]** button.  
The selected track is loaded into the Sampler slot.
  - Loading a sound into a slot that already has a sound loaded may not be possible depending on the **[Preferences]** settings in rekordbox. You may need to clear the slot before loading the new sound.

## Playing Sampler sounds with Performance Pads

- 1 Press the **[SAMPLER]** mode button.  
The unit enters Sampler mode.
- 2 Click the button to the right of **[BANK]** on the **[SAMPLER]** panel in rekordbox to change the Sampler bank.
- 3 Turn the  **[GAIN]** on the **[SAMPLER]** panel to adjust the Sampler volume.
- 4 Press a Performance Pad.  
The track or sound assigned to the relevant slot is played.
  - Sampler slots are set to Performance Pads as follows. (The slots in brackets are for when the Pad mode of deck 2 is set to Sampler mode.)

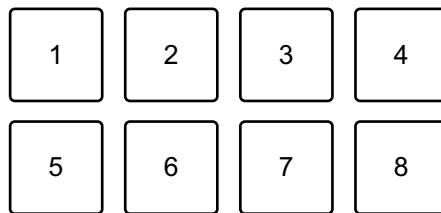

1: Slot 1 (slot 9), 2: Slot 2 (slot 10), 3: Slot 3 (slot 11), 4: Slot 4 (slot 12),  
5: Slot 5 (slot 13), 6: Slot 6 (slot 14), 7: Slot 7 (slot 15), 8: Slot 8 (slot 16)

- 5 During Sampler playback, press the Performance Pad again.  
The sound plays from the beginning again.
- 6 Press a Performance Pad while holding the **[SHIFT]** button during Sampler playback.  
The sound of the slot that is currently playing stops.

## ❖ Using Keyboard mode

Use Performance Pads to play a Hot Cue in different pitches, as if you're using a keyboard.

- 1 Press the **[HOT CUE]** mode button while holding the **[SHIFT]** button.

The unit enters Keyboard mode.

- 2 Press a Performance Pad.

Select the Hot Cue you want to use with Keyboard mode.

- If no Hot Cue is set, the current playback position is set as a Hot Cue. After selecting the Hot Cue which you set, the Hot Cue is used with Keyboard mode.
- To reselect a Hot Cue, press the **[HOT CUE]** mode button while holding the **[SHIFT]** button.

When the Hot Cue is selected, the various pitches are set to the Performance Pads as follows (Default):

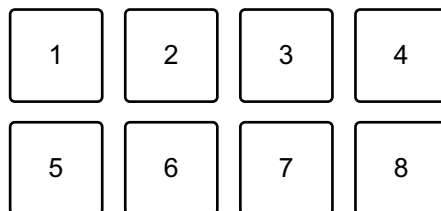

1: +4 Semitones, 2: +5 Semitones, 3: +6 Semitones, 4: +7 Semitones,

5: ±0 Semitones, 6: +1 Semitone, 7: +2 Semitones, 8: +3 Semitones

A semitone is a unit used to determine the pitch of a sound. +1 semitone means the sound is higher in pitch than the original sound by half.

- 3 Press Performance Pad 7 or 8 while holding the **[SHIFT]** button to change the pitch set to the Performance Pad.

- Pad 7: The pitch of the sound rises.
- Pad 8: The pitch of the sound falls.

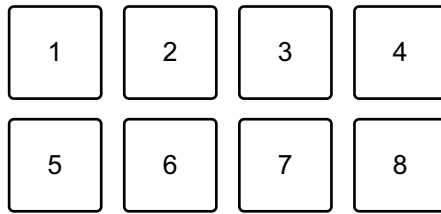

1 through 6: Delete Hot Cue, 7: Semitone up, 8: Semitone down

#### 4 Press a Performance Pad.

Playback starts from the Hot Cue point, with the sound pitch assigned to that pad.

- To delete the Hot Cue, press Performance Pad 1 through 6 while holding the **[SHIFT]** button.

## ❖ Using Pad FX

You can add a wide range of effects to your performances simply by pressing and releasing the Performance Pads.

### 1 Press the **[PAD FX]** mode button.

The unit enters Pad FX mode.

Effects are set to the Performance Pads as follows:

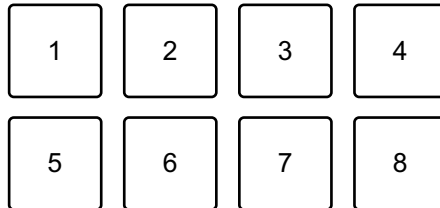

Without holding the **[SHIFT]** button (Pad FX mode)

1: Effect A, 2: Effect B, 3: Effect C, 4: Effect D,  
5: Effect E, 6: Effect F, 7: Effect G, 8: Effect H

While holding the **[SHIFT]** button (Pad FX mode)

1: Effect I, 2: Effect J, 3: Effect K, 4: Effect L,  
5: Effect M, 6: Effect N, 7: Effect O, 8: Effect P

### 2 Press and hold down a Performance Pad, or press and hold down a Performance Pad while holding the **[SHIFT]** button.

The effect turns on. The sound changes according to the type of effect and the number of beats in the settings assigned to that pad.

### 3 Release the Performance Pad.

The effect turns off.

## Using Release FX of Pad FX

You need to assign a Release FX to a Performance Pad in advance.

- 1 Press and hold down a Performance Pad that has an effect other than a Release FX assigned to it, or press and hold down a Performance Pad while holding the **[SHIFT]** button.  
The effect turns on. The sound changes according to the type of effect and the number of beats in the settings assigned to that pad.
- 2 Press the Performance Pad that has a Release FX assigned to it, and release it.  
Or, press a Performance Pad while holding the **[SHIFT]** button, and release it.  
The effect turns off, and the Release FX is added.

## ❖ Using Key Shift

When you press a Performance Pad in Key Shift mode, the key of the track that's currently playing is changed to the pitch set to the pressed pad.

- 1 Press the **[PAD FX]** mode button while holding the **[SHIFT]** button. The unit enters Key Shift mode.

The various pitches are set to the Performance Pads as follows (Default):

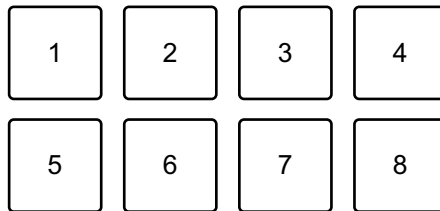

1: +4 Semitones, 2: +5 Semitones, 3: +6 Semitones, 4: +7 Semitones,

5: ±0 Semitones, 6: +1 Semitone, 7: +2 Semitones, 8: +3 Semitones

A semitone is a unit used to determine the pitch of a sound. +1 semitone means the sound is higher in pitch than the original sound by half.

- 2 Press Performance Pad 7 or 8 while holding the **[SHIFT]** button to change the pitch set to the Performance Pad.
  - Pad 7: The pitch of the sound rises.
  - Pad 8: The pitch of the sound falls.

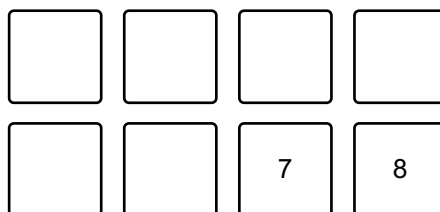

7: Semitone up, 8: Semitone down

- 3 Press a Performance Pad.

The track's key is changed to the pitch assigned to the pad.



## Using Sample Scratch

Use this feature to take the track loaded into the sampler slot and load it onto a deck.

- 1 Press the **[SAMPLER]** mode button while holding the **[SHIFT]** button.

The unit enters Sample Scratch mode.

- 2 Press a Performance Pad.

The sound loaded in the sampler slot assigned to the pad is loaded onto the deck so you can scratch with it and bend the pitch, etc.

- If the Play mode of the sampler slot is set to Oneshot, playback starts when the sound is loaded to the deck.
- If the Play mode of the sampler slot is set to loop, manual loop is set on the deck and playback starts when the sound is loaded to the deck.
- If the sampler slot is set to Gate, the sound plays as Cue Point Sampler while holding the pad when the sound is loaded to the deck.

Sampler slots are set to the Performance Pads as follows. (The slots in brackets are for when the Pad mode of deck 2 is set to Sample Scratch mode.)

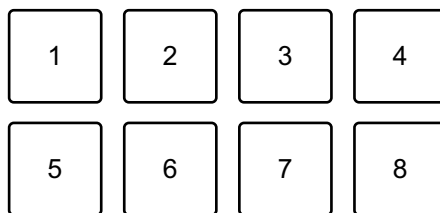

1: Slot 1 (slot 9), 2: Slot 2 (slot 10), 3: Slot 3 (slot 11), 4: Slot 4 (slot 12),  
5: Slot 5 (slot 13), 6: Slot 6 (slot 14), 7: Slot 7 (slot 15), 8: Slot 8 (slot 16)

To unload the track, press the Performance Pad while holding the **[SHIFT]** button.

---

## Setting and calling up a cue point or loop point

### ❖ Setting a cue point or loop point

- 1 Pause the track and move the playback position to where you want to set a cue point or loop point.
- 2 Press the **[CUE]** button while the track is paused.
- 3 Press the **[CUE/LOOP MEMORY]** button.  
The cue point or loop point is saved.

### ❖ Calling up the cue point or loop point

Press the **[CUE/LOOP CALL ►]** or **[CUE/LOOP CALL ◀]** button.  
The cue point or loop point is called up.

### ❖ Deleting the cue point or loop point

- 1 Press the **[CUE/LOOP CALL ►]** or **[CUE/LOOP CALL ◀]** button.  
The cue point or loop point is called up.
- 2 Press the **[CUE/LOOP MEMORY]** button while holding the **[SHIFT]** button.  
The cue point or loop point is deleted.

---

## Using Fader Start

### ❖ Using Channel Fader Start

- 1 Set the cue point.

Pause the track at the position you want to start playback from, then press the **[CUE]** button on that deck.

- 2 While holding the **[SHIFT]** button, move the channel fader from the bottom to the top.

Playback starts from the cue point.

- If you move the channel fader back to the bottom while holding the **[SHIFT]** button during playback, the track instantly jumps back to the cue point and playback pauses. (Back Cue)

When no cue point is set, playback starts from the beginning of the track.

### ❖ Using Crossfader Start

- 1 Set the cue point.

Pause the track at the position you want to start playback from, then press the **[CUE]** button on that deck.

- 2 Move the crossfader all the way to the left or right side.

If you want to use Crossfader Start to trigger playback on channel 2, set the crossfader to the left side, and vice versa.

- 3 While holding the **[SHIFT]** button, move the crossfader towards the opposite side from where it's set.

Playback starts from the cue point.

- If you move the crossfader back while holding the **[SHIFT]** button during playback, the playback position instantly jumps back to the cue point and pauses. (Back Cue)

When no cue point is set, playback starts from the beginning of the track.

## Analyzing tracks

Track analysis starts when you drag and drop a music file, or a folder containing music files, into the Track List in rekordbox.

- If a track is loaded to a deck before analysis is complete, it may take some time to display its BPM and waveform.
- Depending on the number of tracks, analysis may take some time.

## Using Beat FX

You can apply effects that match the tempo (BPM) of the track loaded on the deck.

- 1 Click **FX** in the top-left of the rekordbox screen to display the FX panel, and click **•••** to choose settings for Multi mode.
- 2 Press the **[BEAT FX SELECT]** button on the unit.

The selected Beat FX change as follows each time you press the button:

FX1-1 → FX1-2 → FX1-3 → FX2-1 → FX2-2 → FX2-3 → FX1-1

If you press the **[BEAT FX SELECT]** button while holding the **[SHIFT]** button, the selected Beat FX change in the reverse order.

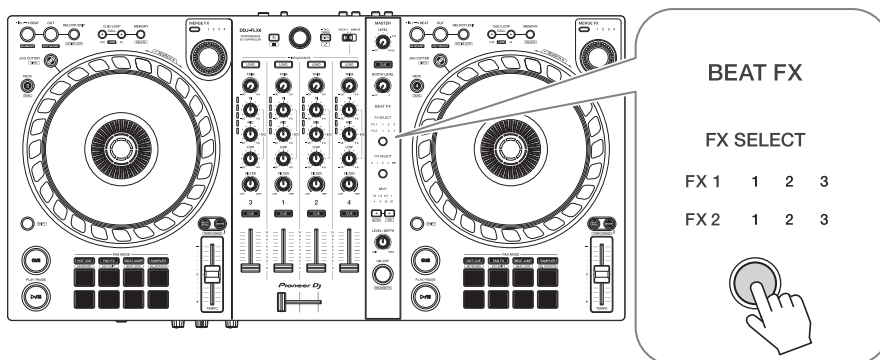

Beat FX are displayed on the FX panel in rekordbox as follows:

- FX1-1
  - **[FX SELECT]** indicators:
    - FX1 1 2 3
    - FX2 1 2 3

– **[FX]** panel:



- FX1-2

– **[FX SELECT]** indicators:

FX1 1 2 3

FX2 1 2 3

– **[FX]** panel:

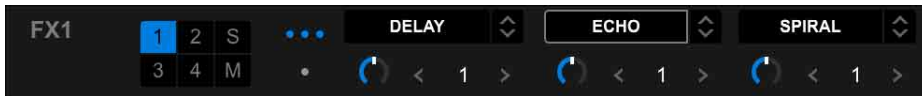

- FX1-3

– **[FX SELECT]** indicators:

FX1 1 2 3

FX2 1 2 3

– **[FX]** panel:



- FX2-1

– **[FX SELECT]** indicators:

FX1 1 2 3

FX2 1 2 3

– **[FX]** panel:



- FX2-2

– **[FX SELECT]** indicators:

FX1 1 2 3

FX2 1 2 3

– **[FX]** panel:



- FX2-3

– **[FX SELECT]** indicators:

FX1 1 2 3

FX2 1 2 **3**

– **[FX]** panel:



### 3 Press the **[BEAT FX CH SELECT]** button.

The channel that Beat FX will be applied to changes each time you press the button.

- **[1]**: Applies Beat FX to the sound of channel 1.
- **[2]**: Applies Beat FX to the sound of channel 2.
- **[3]**: Applies Beat FX to the sound of channel 3.
- **[4]**: Applies Beat FX to the sound of channel 4.
- **[MST]**: Applies Beat FX to the sound of the **[MASTER]** channel.

### 4 Press the **[BEAT ◀]** or **[BEAT ▶]** button.

Set the number of beats (or parameters) synchronized to the effect sound.

- When set to 2 beats, 1 and 4 flash.
- When set to more than 16 beats, 16 flashes.
- When set to less than 1/4 beat, 1/4 flashes.
- When the set number of beats is a minus number, the number flashes rapidly.
- When the parameter is in %, no numbers are lit.

### 5 Press the **[BEAT FX ON/OFF]** button.

The Beat FX is applied to the sound of the channel you set in step 3.

You can adjust the parameter of Beat FX by turning the **[BEAT FX LEVEL/DEPTH]** knob.

When Beat FX is turned on, the button flashes.

- Press the **[BEAT FX ON/OFF]** button again to turn off Beat FX.

6 Press the **[BEAT FX ON/OFF]** button and release it while holding the **[SHIFT]** button.

Beat FX is turned off, and Release FX is applied.

### ❖ **Switching Beat FX Tempo mode**

To set the tempo for Beat FX, there are 2 modes you can use: BPM Auto mode and BPM Tap mode.

- The default setting is BPM Auto mode.

#### **BPM Auto mode**

The track's BPM is used as the base for the effect's tempo.

#### **BPM Tap mode**

The BPM used as the base for Beat FX is set to match the tempo at which you tap the **[BEAT ►]** button while holding the **[SHIFT]** button.

#### **Setting to BPM Tap mode**

Press the **[BEAT ►]** button while holding the **[SHIFT]** button.

- To return to BPM Auto mode, press the **[BEAT ◀]** button while holding the **[SHIFT]** button.

## Using Merge FX

You can use the **[MERGE FX]** knob to apply effects for mixing from the current track to the next.

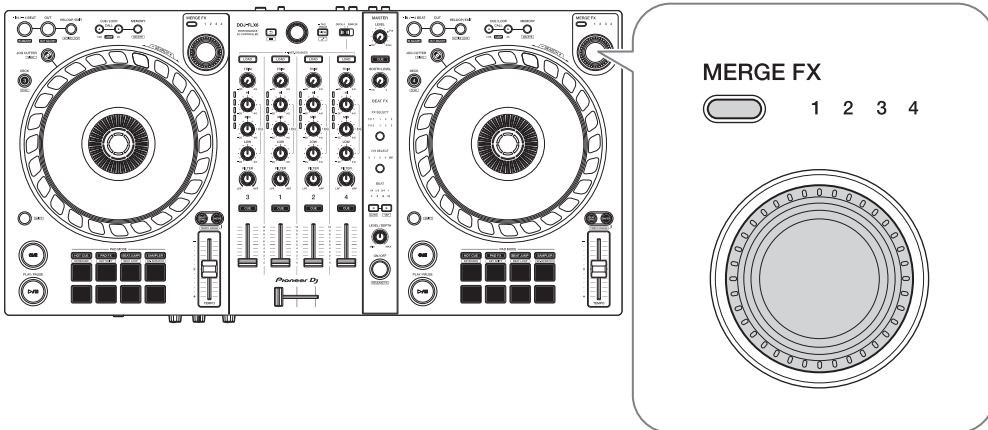

### 1 Press the **[MERGE FX]** select button.

The selected Merge FX type changes in order of Merge FX1, 2, 3, 4 each time you press the button.

If you press the **[MERGE FX]** select button while holding the **[SHIFT]** button, the effect type changes in the reverse order.

- You can also change the Merge FX type from the menu in the **[MFX]** panel in rekordbox.



### 2 Press the **[MERGE FX]** knob.

Merge FX turns on.

The effect is applied to the track that's currently playing.

At the same time, sample sound or oscillator sound starts playing.

- Depending on the selected Merge FX type, the effect is applied as you turn the **[MERGE FX]** knob.



- You can also turn Merge FX on by clicking the MERGE FX On/Off button in the **[MFX]** panel in rekordbox.



### 3 Turn the **[MERGE FX]** knob.

The effect is applied to the track that's currently playing.

The effect sound and the sample sound/oscillator sound change.

- You can also change the effect sound and the sample sound/oscillator sound by turning the Merge FX parameter knob in the **[MFX]** panel in rekordbox.



### 4 Press the **[MERGE FX]** knob again.

Merge FX turns off.

Release FX is applied to the track, the effect sound, and the sample sound/oscillator sound, then the second sample sound plays after a set amount of time.

- If **[Preferences] > [Controller] > [Effect] tab > [MERGE FX] > [Stop playing the operating deck after MERGE FX finishes]** is set, playback stops.
- You can also turn Merge FX off by clicking the MERGE FX On/Off button in the **[MFX]** panel in rekordbox.



- The Merge FX parameter knob on the **[MFX]** panel in rekordbox automatically moves to the center position when you turn off Merge FX.
- Depending on various settings, the action of the effect may differ.
- To turn Merge FX off, press the **[MERGE FX]** knob while holding the **[SHIFT]** button. You can also turn Merge FX off by clicking the MERGE FX On/Off button in the **[MFX]** panel in rekordbox while holding the **[SHIFT]** button.

- To adjust the volume of sample sound/oscillator sound, turn the **[MERGE FX]** knob while holding the **[SHIFT]** button. You can also adjust the sound level by turning the MERGE FX SAMPLE VOL knob in the **[MFX]** panel.
- When you use a Hot Cue after turning off Merge FX, sample playback or pausing the deck will be canceled and the playback position will jump to the Hot Cue point to continue playback.  
(Sample sounds that are already playing will not be canceled.)

## Changing the Merge FX settings

- 1 Click  in the [MFX] panel in rekordbox.



The **[MERGE FX Settings]** screen is displayed, and you can change the settings.

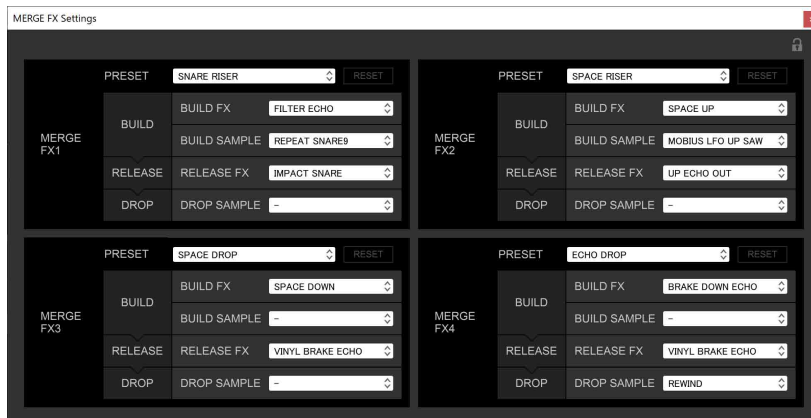

- Change the settings below.
  - **[PRESET]**: Changes the preset for Merge FX.
  - **[BUILD FX]**: Changes the type of effect applied to the track when Merge FX is turned on.
  - **[BUILD SAMPLE]**: Changes the sample sound/oscillator sound triggered when Merge FX is turned on.
  - **[RELEASE FX]**: Changes the Release FX applied when Merge FX is turned off.
  - **[DROP SAMPLE]**: Changes the sample sound triggered after the Release FX applied when Merge FX is turned off.
- You need to select the sample sound when you make the following settings. Click the **[?]** icon to select the sample sound.  
(You need to load the sample sound into the sampler slot before you do this.)
  - **[BUILD SAMPLE]** > **[REPEAT SAMPLE]**
  - **[BUILD SAMPLE]** > **[REPEAT UP SAMPLE]**
  - **[DROP SAMPLE]** > **[SAMPLER]**

2 Click .

Settings can be locked. Lock/unlock will be switched by each time you click.

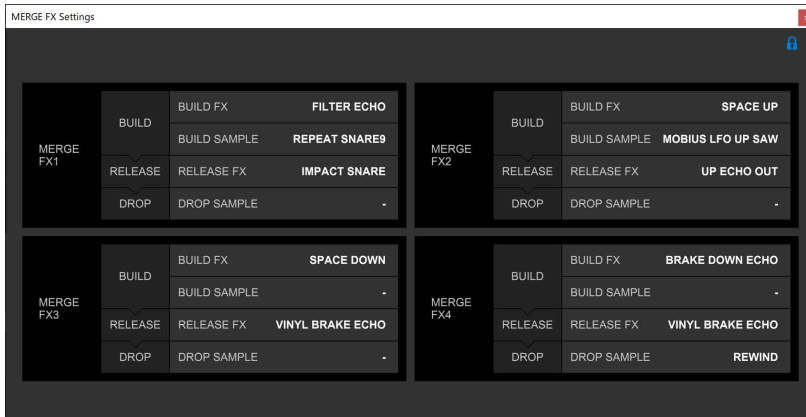



- If you click **[RESET]** after changing the preset, the default setting of the preset is restored.

3 Click the **[x]** button.

The **[MERGE FX Settings]** screen closes.

## Recording

rekordbox has a recording feature that you can use to capture your performances. For detailed instructions on recording, see the rekordbox Instruction Manual.

- 1 Click the  button at the top-left of the rekordbox screen to display the **[REC]** panel.
- 2 Click  on the **[REC]** panel in rekordbox to start recording.
  - If you click  again, recording stops.
  - When recording is complete, the file is automatically saved.
  - You can change the saving destination of files in the **[Preferences]** > **[Controller]** > **[Recordings]** tab in rekordbox.
  - You can't record sound from the **[MIC]** input terminal.

---

## Using a microphone

- 1 Connect a microphone to the **[MIC]** input terminal.
  - 2 Turn the **[MIC LEVEL]** knob.  
Adjust the volume of the sound output from the **[MIC]** input terminal.
    - The sound comes out at a high volume if the knob is turned all the way to the right.
  - 3 Input audio to the microphone.
    - You can't affect the microphone sound input to the unit using rekordbox.
    - Sound input from the **[MIC]** input terminal can't be output from the speaker(s) of your PC/Mac even if PC Master Out is turned on.
- 

## Using Jog Cutter

Turn on **[JOG CUTTER]** and move the jog wheel to create professional-sounding scratch effects (“scratch play”) with a section of a track (or a sample, when using Sample Scratch).

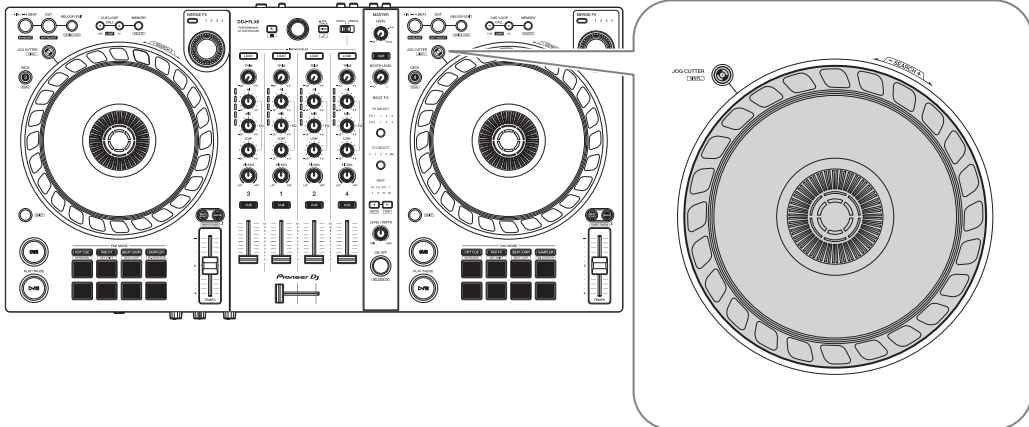

- 1 Set a Hot Cue or a cue point.  
In Hot Cue mode, press the Performance Pad to set a Hot Cue. Or, press the **[CUE]** button to set a cue point when playback is paused.
  - If you've already set Hot Cues, call up the one you want to “scratch” with.

- When using Jog Cutter without setting Hot Cues or a cue point, “scratch play” starts from the cue point which is set at loading.
- Even if a Hot Cue or a cue point is set, “scratch play” starts from the current playback position if **[Jumps to the last played HOT CUE/CUE point.]** isn’t selected in **[Preferences] > [Controller] > [Deck] > [JOG CUTTER]**.
- You can also use a Hot Loop instead of a Hot Cue or a cue point.

## 2 Press the **[JOG CUTTER]** button.

Jog Cutter mode turns on.

- If Vinyl mode isn’t turned on, turn it on before you press the **[JOG CUTTER]** button.
- Jog Cutter mode can’t be used on multiple decks at the same time. If you press one **[JOG CUTTER]** button and then the other, the button that is previously turned on will be turned off.

## 3 Hold the top of the jog wheel.

The playback position moves to the Hot Cue or cue point and “scratch play” starts.

## 4 Move the jog wheel to start “scratch play”.

When you move the jog wheel back and forth, you’ll hear a professional-sounding scratch effect applied to the sound.

- Different scratch effects are assigned to 6 areas of the jog wheel as follows. The type of “scratch play” changes as you change the scratch area by checking the indicator that appears when you touch the top of the jog wheel.

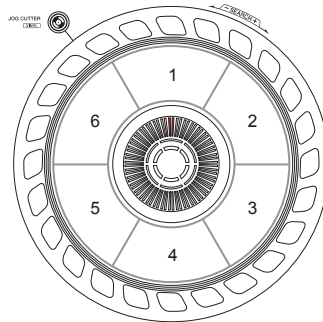

- When BPM is 150 or more, the scratch speed is halved. If you don’t select **[While scratching, scratch tempo is half tempo if BPM is over**

**threshold.]** in rekordbox under **[Controller] > [Deck] > [JOG CUTTER]** in **[Preferences]**, the scratch speed will be same as BPM. You can change the BPM threshold to halve the scratch playback speed in **[Preferences]**.

- 5 Release your hand from the top of the jog wheel.  
“Scratch play” stops and the track continues to play as normal from the Hot Cue/cue point/Hot Loop/playback position.
- 6 Press the **[JOG CUTTER]** button again.  
Jog Cutter mode turns off.

---

## Playing Sampler sound on channel 4

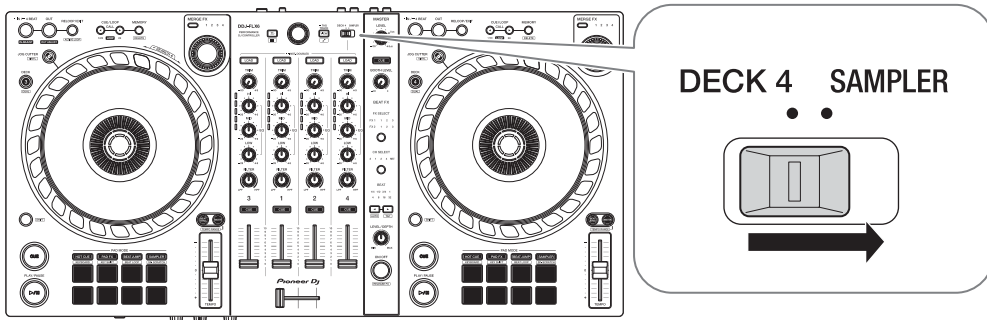

- Set the **[DECK4/SAMPLER]** selector switch to **[SAMPLER]**.  
The input to channel 4 changes to the sampler sound, and you can adjust the Trim, EQ, Filter, channel fader, and crossfader to affect the sound.
- Sound from deck 4 can't be output from channel 4 while the **[DECK4/SAMPLER]** selector switch is set to **[SAMPLER]**.

---

## Changing the settings in rekordbox

You can change the settings of the unit in rekordbox under **[Controller]** in **[Preferences]**.

When you connect the unit to rekordbox, you can change the following settings:

**[Controller]** > **[Deck]** tab:

**[JOG CUTTER]** setting

- **[Jumps to the last played HOT CUE/CUE point.]**:

The playback position moves to the Hot Cue or cue point you've called, or the one you last set, when you use Jog Cutter.

When this setting isn't selected, Jog Cutter starts from the current playback position.

- **[While scratching, scratch tempo is half tempo if BPM is over threshold.]**:

If BPM is over threshold, scratch tempo is halved. If you don't select this setting, the scratch speed is same speed as BPM. The threshold can be selected from 140, 150, 160, 170, or 180. The default setting is 150.

**[Back Spin Length]** setting

When using the Back Spin feature with the jog wheel, the length of the Back Spin is different from the length of the jog wheel rotation.

You can choose the length of the Back Spin from 3 options: short, normal, or long.

- **[short]**: Back Spin length short
- **[normal]**: Back Spin length normal
- **[long]**: Back Spin length long

**[Controller]** > **[Mixer]** tab:

**[Fader Start]** setting

Change the setting of the Fader Start function.



Select **[Activate the fader start when moving a channel fader or the crossfader while pressing the SHIFT button.]** to turn the setting on.

### **[CROSSFADER] > [Cut Lag] setting**

Adjust the amount of Cut Lag at both edges of the crossfader.

You can make adjustments in increments of 0.1 mm within a range of 0.3 mm to 5.5 mm.

- The default Cut Lag amount is 1.0 mm.
- The setting amount for the Cut Lag is a guide, and may not be exact.

### **[Booth Output] setting**

Change whether or not the microphone sound comes out of the booth channel.

If you don't select **[Don't output microphone sound to the Booth output.]**, the microphone sound comes out of the booth channel. If you select the setting, microphone sound doesn't come out of the booth channel.

### **[Controller] > [Effect] tab:**

- **[Enable MERGE FX]:**

Merge FX is enabled and the **[MFX]** panel is displayed on the FX panel.

When the unit is connected, this setting is enabled.

- **[Stop playing the operating deck after MERGE FX finishes.]:**

When you select this, playback automatically stops on the deck after Merge FX is canceled.

---

---

# Serato DJ Pro

---

---

## Installing Serato DJ Pro

### ❖ Installing (Mac)

**Do not connect the unit to your Mac until installation is complete.**

- Close all programs on your Mac.
- 1 Unzip the downloaded Serato DJ Pro software file.
  - 2 Double-click the unzipped software file to launch the installer.
  - 3 Read the terms of the License Agreement carefully and if you agree, click **[Agree]**.

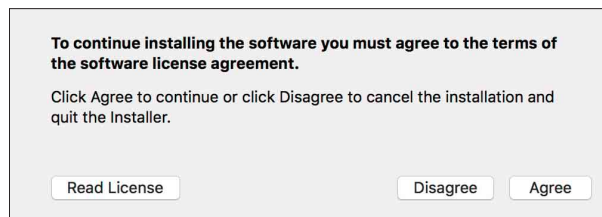

- If you don't agree to the contents of the License Agreement, click **[Disagree]** to cancel the installation.
- 4 Click **[Install]**.
  - 5 Follow the on-screen instructions to install the software.

6 Click **[Close]** to quit the installer.

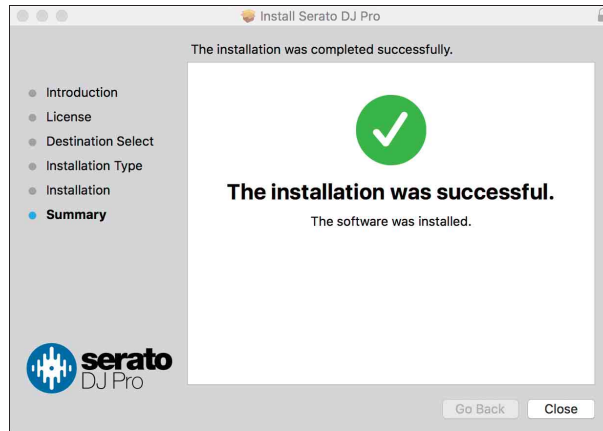

## ❖ Installing (Windows)

**Do not connect the unit to your PC until installation is complete.**

- Log into your PC as an administrator before starting the installation.
- Close all programs on your PC.

- 1 Unzip the downloaded Serato DJ Pro software file.
- 2 Double-click the unzipped software file to launch the installer.
- 3 Read the terms of the License Agreement carefully and if you agree, select **[I agree to the license terms and conditions]**, then click **[Install]**.
  - If you don't agree to the contents of the License Agreement, click **[Close]** to cancel the installation.



A message indicating successful installation appears when installation is complete.

- 4 Click **[Close]** to quit the Serato DJ Pro installer.

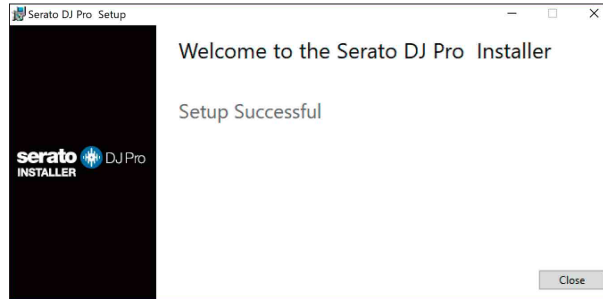

---

## Activating FX Pack and Pitch 'n Time DJ

\* If FX Pack is not activated, you can't use Merge FX. Before using Merge FX, be sure to activate FX Pack.

Activate FX Pack and Pitch'n Time DJ on the My Serato screen.

You'll need an internet connection to do this. (A separate contract with an internet service provider is needed, which you may have to pay for.)

For support information about FX Pack and Pitch'n Time DJ, visit the Serato website.

[serato.com/](http://serato.com/)

### ❖ Activating FX Pack

- 1 Connect the unit to your PC/Mac using the USB cable.
- 2 Launch Serato DJ Pro.
- 3 Click **[My Serato]**.
- 4 Log in with account credentials you've registered on.  
[serato.com](http://serato.com/).
- 5 Click **[Enter Voucher Code]**.
- 6 Enter the supplied voucher code, then click **[Activate]**.
- 7 Reboot Serato DJ Pro.

## ❖ **Activating Pitch'n Time DJ**

- 1 Connect the unit to your PC/Mac using the USB cable.
- 2 Launch Serato DJ Pro.
- 3 Click **[My Serato]**.
- 4 Log in with account credentials you've registered on.  
[serato.com](https://www.serato.com).
- 5 Click **[Enter Voucher Code]**.
- 6 Enter the supplied voucher code, then click **[Activate]**.
- 7 Click the **[SETUP]** icon in the top-right corner of the screen.
- 8 Double-click the **[Expansion Packs]** tab.
- 9 Select **[Pitch'n Time DJ]**.
- 10 Mark the **[Enable Pitch'n Time DJ]** check box.
- 11 Click the **[SETUP]** icon to close the SETUP screen.
- 12 Reboot Serato DJ Pro.

## Basic use

### Starting Serato DJ Pro

This manual mainly focuses on explaining the hardware functions of the unit. For detailed instructions on using the Serato DJ Pro software, see the Serato DJ Pro software manual.

#### For Mac

In Finder, open the **[Applications]** folder, then click the **[Serato DJ Pro]** icon.

#### For Windows 10

From the **[Start]** menu, click **[Serato] > [Serato DJ Pro]** icon.

The following screen shows after Serato DJ Pro launches:

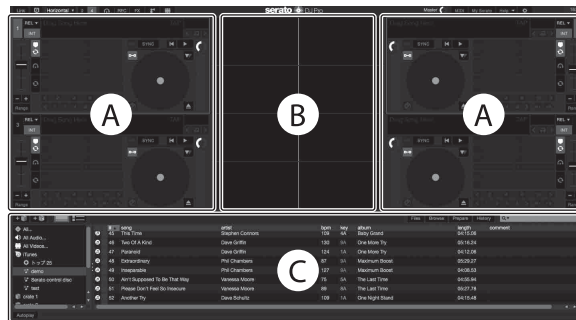

- The **[BUY/ACTIVATE]** icon may appear on the right side of the screen when you launch Serato DJ Pro for the first time. However, you don't need a license to use the software with this unit.

The following screen shows when tracks are loaded onto decks in Serato DJ Pro:

Click **[Library]** in the top-left corner of the screen, then select **[Vertical]** or **[Horizontal]** from the pull-down menu to change the screen layout.

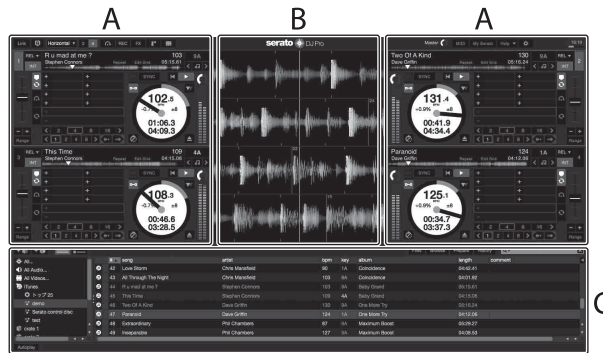

## A Deck section

Track information (track name, artist name, BPM, etc.), the overall waveform, and other information about the loaded track is displayed.

## B Waveform display

The waveform of the loaded track is displayed.

## C Browser section

Tracks in the library, or crates containing multiple tracks, are displayed.



## Importing music files (tracks)

- There are various ways to import tracks into Serato DJ Pro. For details, see the Serato DJ Pro software manual.
- If you're already using Serato Limited's DJ software (e.g. Scratch Live, ITCH, or Serato DJ Intro) and you've already created track libraries, you can use these libraries with Serato DJ Pro.
- If you're using Serato DJ Intro and you've already created track libraries, you may need to reanalyze tracks to use them with Serato DJ Pro.

The typical way to import music files (tracks) is as follows:

- 1 Click the **[Files]** button in the Serato DJ Pro screen to open the **[Files]** panel.  
The contents of your PC/Mac or the hard drive/device connected to the PC/Mac are displayed in the **[Files]** panel.
- 2 Click the folder containing the tracks you want to add to your library.
- 3 Drag and drop the selected folder to the crates panel.  
A crate is created and the tracks are added to your library.

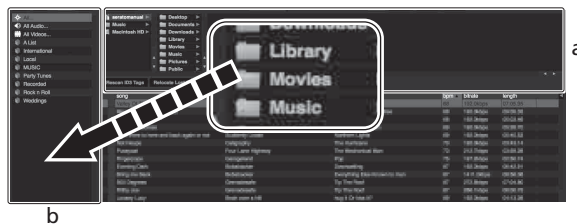

a **[Files]** panel

b Crates panel

---

## Loading a track onto a deck

The following explains how to load a track onto deck **[1]** as an example:

Turn the rotary selector to select a track from **[Collection]**, then press the **[LOAD]** button for deck 1 (second from the left).

The track is loaded onto the deck.

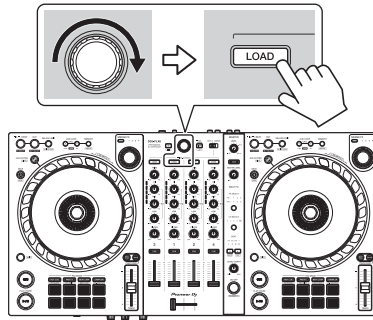

---

## Playing a track

This section explains how to play sound from deck 1 (left) as an example.

- 1 Set the positions of the knobs etc. as shown below.
  - **[TRIM]** knob: turned fully counterclockwise
  - **[EQ (HI/MID/LOW)]** knobs: center position (12 o'clock)
  - **[FILTER]** knob: center position
  - Channel fader: bottom position
  - **[MASTER LEVEL]** knob: turned fully counterclockwise
  - Crossfader: center position
- 2 Press the **[PLAY/PAUSE ▶/III]** button to play the track.

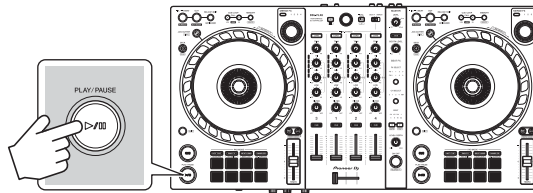

- 3 Turn the **[TRIM]** knob.  
Adjust the **[TRIM]** knob so the channel level indicator lights up orange at the loudest part of the track.

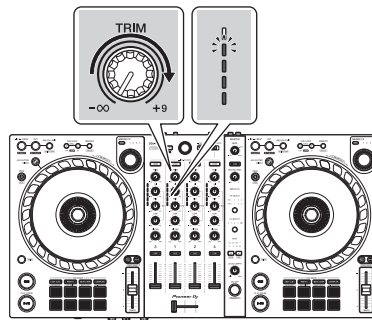

4 Move the channel fader to the top.

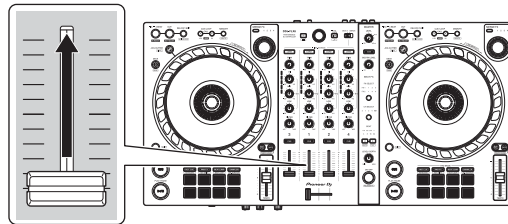

5 Turn the **[MASTER LEVEL]** knob to adjust the volume of the speakers to a level you're happy with.

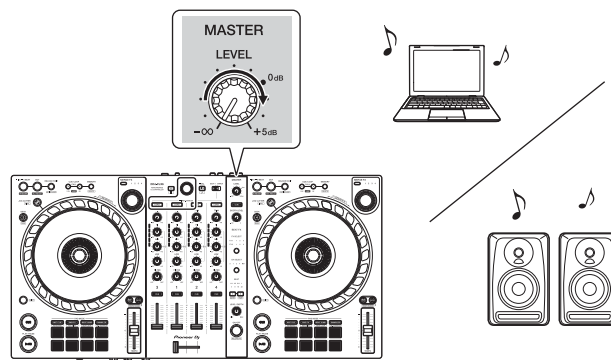

- If you can't output sound from the **[MASTER]** output terminals or the unit isn't recognized by your PC/Mac, refer to the **[FAQ]** on the Pioneer DJ support website.

[pioneerdj.com/support/](http://pioneerdj.com/support/)

---

## Monitoring with headphones

This section explains how to play sound from deck 1 (left) as an example.

- 1 Set the positions of knobs etc. as shown below.
  - **[HEADPHONES MIX]** knob: Center
  - **[HEADPHONES LEVEL]** knob: Turned fully counterclockwise
- 2 Press the headphone **[CUE]** button for channel 1.
- 3 Turn the **[HEADPHONES LEVEL]** knob.  
Adjust the headphones volume to a level you're happy with.

---

## Quitting Serato DJ Pro

Click the **[x]** button.

---

## Turning off the unit

Disconnect the USB cable to turn off the unit.

---

## Advanced use

---

---

### Using 4 Beat Loop

While a track is playing, press and hold the **[IN/4BEAT]** button for at least a second.

Loop playback starts with 4 beats from the point where you press the button.

#### ❖ Canceling loop playback

Press the **[RELOOP/EXIT]** button.

When the loop out point is reached, the rest of the track continues to play without returning to the loop in point.

---

### Using Manual Loop

You can use Manual Loop to choose the section you want to loop in a track.

- 1 During playback, press the **[IN/4BEAT]** button at the point you want to start looping (the loop in point).
- 2 Press the **[OUT]** button at the point you want the loop to end (the loop out point).  
Loop playback starts.

## ❖ Cutting the loop

Press the **[CUE/LOOP CALL ◀]** button during loop playback.  
Each time you press the button, the loop cuts in half.

- The loop length can be cut in half even during 4 Beat Loop playback.

## ❖ Extending the loop

Press the **[CUE/LOOP CALL ▶]** button during loop playback.  
Each time you press the button, the loop doubles in length.

- The loop length can be doubled even during 4 Beat Loop playback.

## ❖ Canceling a loop

Press the **[RELOOP/EXIT]** button.

The rest of the track continues to play without returning to the loop in point.

## ❖ Changing the loop in point

Press the **[IN/4BEAT]** button and turn the jog wheel during loop playback.

The loop in point changes.

## ❖ Changing the loop out point

Press the **[OUT]** button and turn the jog wheel during loop playback.

The loop out point changes.

---

## Using the Performance Pads

You can switch functions using the respective Pad mode buttons (the **[HOT CUE]** mode button, **[PAD FX]** mode button, **[BEAT JUMP]** mode button, and **[SAMPLER]** mode button).

### ❖ Using Hot Cues

You can start playback instantly from the position where a Hot Cue is set.

- Up to 8 Hot Cues can be set and saved for each track in Serato DJ Pro.

- 1 Press the **[HOT CUE]** mode button.

The unit enters Hot Cue mode.

- 2 When the track is playing or paused, press a Performance Pad to set a Hot Cue.

Hot Cues are set to Performance Pads as follows:

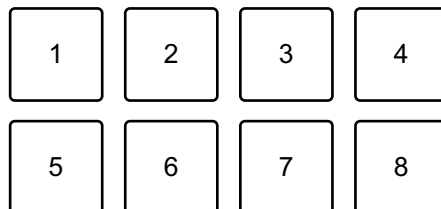

1: Hot Cue A, 2: Hot Cue B, 3: Hot Cue C, 4: Hot Cue D,  
5: Hot Cue E, 6: Hot Cue F, 7: Hot Cue G, 8: Hot Cue H

- 3 Press a Performance Pad you've set a Hot Cue for.

Playback starts from the Hot Cue point.

- You can clear Hot Cues by pressing a Performance Pad while holding the **[SHIFT]** button.



## ❖ Using Roll

If you press a Performance Pad when the unit is in Roll mode, a loop with the number of beats assigned to the pad is set and the loop plays until you release the pad.

During Loop Roll playback, normal playback with the original rhythm continues in the background (but you can only hear the Loop Roll). When you cancel Loop Roll, playback resumes from the position reached in the background.

- 1 Press the **[PAD FX]** mode button.

The unit enters Roll mode.

- 2 Press and hold down a Performance Pad (1 through 8).

Loop Roll playback starts with the number of beats in the settings assigned to that pad.

Playback continues in the background during Loop Roll playback (but you can only hear the Loop Roll).

- Press the **[CUE/LOOP CALL ◀]** or **[CUE/LOOP CALL ▶]** button during Loop Roll to change the number of beats for the Loop Roll that's currently playing.

For example, when you set the pads to 1/8 – 16 beats, the pad's settings are as shown below.

1	2	3	4
5	6	7	8

1: 1/8 beat, 2: 1/4 beat, 3: 1/2 beat, 4: 1 beat,  
5: 2 beats, 6: 4 beats, 7: 8 beats, 8: 16 beats

The range of beats set for Loop Roll is shown on the Serato DJ Pro screen.

- 3 Release the Performance Pad.

Loop Roll is canceled, and playback resumes from the position reached in the background.

## ❖ Using Auto Loop

When you press a Performance Pad, a loop with the number of beats assigned to the pad is set and the loop plays until you release the pad.

- 1 Press the **[BEAT JUMP]** mode button.  
The unit enters Auto Loop mode.
- 2 Press a Performance Pad during playback.  
Loop playback starts with the number of beats in the setting assigned to that pad.
  - When you press the same Performance Pad again, loop playback is canceled.

## ❖ Using Sampler

You can use the Performance Pads to play tracks or sounds assigned to the Sampler slots.

- 1 Open the **[SAMPLER]** panel in Serato DJ Pro.
- 2 Press the **[SAMPLER]** mode button on the unit.  
The unit enters Sampler mode.
- 3 Choose a Sampler bank on the Serato DJ Pro screen.  
The sampler has 4 banks, A, B, C, and D, and each bank has 8 slots.
- 4 Drag and drop tracks or sounds to load them into the **[SAMPLER]** panel's slots.  
The sampler settings and loaded tracks are saved.
- 5 Press a Performance Pad.  
The track or sound assigned to the relevant slot is played.

- The playback method differs depending on the Sampler mode in Serato DJ Pro. For details, see the Serato DJ Pro software manual.

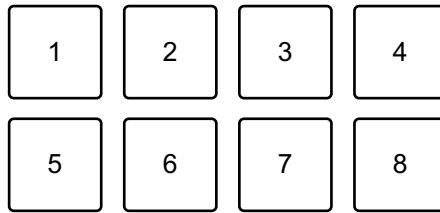

1: Slot 1, 2: Slot 2, 3: Slot 3, 4: Slot 4,  
5: Slot 5, 6: Slot 6, 7: Slot 7, 8: Slot 8

- When you press a Performance Pad while holding the **[SHIFT]** button, the sound of the slot that is currently playing stops.

## ❖ Using Cue Loop

- 1 Press the **[HOT CUE]** mode button while holding the **[SHIFT]** button.

The unit enters Cue Loop mode.

- 2 Press a Performance Pad while a track is playing.

The loop in point is set on the Hot Cue slot and loop playback starts.

- The loop length depends on the number of beats set for Auto Loop. Loop in points are assigned to the Performance Pads as follows:

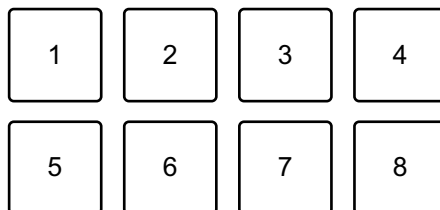

1: Loop 1, 2: Loop 2, 3: Loop 3, 4: Loop 4,  
5: Loop 5, 6: Loop 6, 7: Loop 7, 8: Loop 8

- With the Cue Loop function, the Hot Cue point is used as the loop in point. If you press a Performance Pad which has a Hot Cue set, a loop starts from that Hot Cue point.

## Cutting the loop

Press the **[CUE/LOOP CALL ◀]** button during loop playback. Each time you press the button, the loop cuts in half.

## Extending the loop

Press the **[CUE/LOOP CALL ▶]** button during loop playback. Each time you press the button, the loop doubles in length.

## Returning to the loop in point

Press the same Performance Pad while holding the **[SHIFT]** button. The playback position returns to the set loop in point and the loop keeps playing.

## Canceling a loop

Press the same Performance Pad again. The rest of the track continues to play without returning to the loop in point.

## ❖ Using Saved Loop

You can save a loop to a loop slot in Serato DJ Pro and call it up when you want to.

- 1 Press the **[PAD FX]** mode button while holding the **[SHIFT]** button. The unit enters Saved Loop mode.
- 2 Press a Performance Pad during loop playback.

- The loop is assigned to the relevant loop slot in Serato DJ Pro.

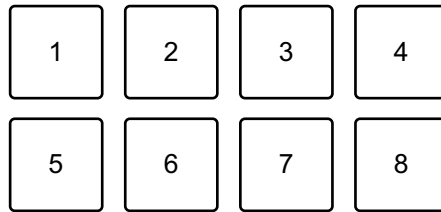

1: Slot 1, 2: Slot 2, 3: Slot 3, 4: Slot 4,  
5: Slot 5, 6: Slot 6, 7: Slot 7, 8: Slot 8

- 3 Press a Performance Pad while holding the **[SHIFT]** button.  
The playback position returns to the set loop in point and the loop keeps playing.

## Cutting the loop

Press the **[CUE/LOOP CALL ◀]** button during loop playback.  
Each time you press the button, the loop cuts in half.

## Extending the loop

Press the **[CUE/LOOP CALL ▶]** button during loop playback.  
Each time you press the button, the loop doubles in length.

## Returning to the loop in point

Press the same Performance Pad while holding the **[SHIFT]** button.  
The playback position returns to the loop in point and loop playback continues.

## Canceling a loop

Press the same Performance Pad again.  
The rest of the track continues to play without returning to the loop in point.

## ❖ Using Slicer Loop

Slicer Loop takes a section of the track that's currently playing (known as a domain and defined by a specified number of beats) and divides it into 8 equal sections. These 8 sliced sections are assigned to the respective Performance Pads. While you hold down a Performance Pad, the sound for the section assigned to that pad plays in a loop. While playing a loop of the pad's sound, normal playback of the track with the original rhythm continues in the background (but you only hear the loop). When you release the Performance Pad and loop playback ends, track playback resumes from the position reached by that time.

- You can't use the Slicer function with tracks that have no beatgrid set. For details on setting beatgrids, read the Serato DJ Pro software manual.

- 1 Press the **[BEAT JUMP]** mode button while holding the **[SHIFT]** button.

The unit enters Slicer Loop mode.

- 2 Set the number of beats in **[DOMAIN]**.

You can choose from 6 settings: 2 beats, 4 beats, 8 beats, 16 beats, 32 beats, or 64 beats.

The domain is divided equally into 8 sliced sections, which are assigned to the Performance Pads as shown below.

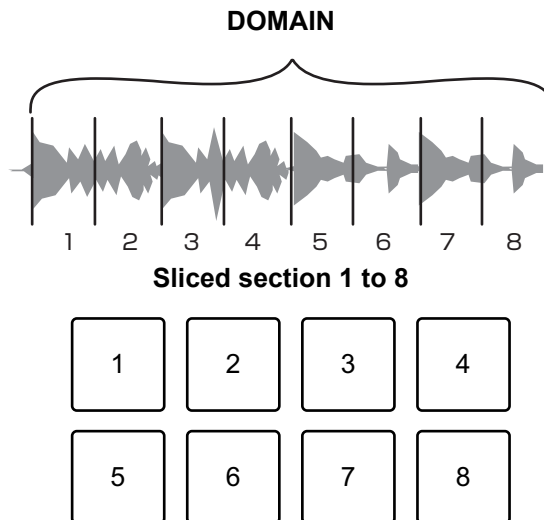

1: Section 1, 2: Section 2, 3: Section 3, 4: Section 4,  
5: Section 5, 6: Section 6, 7: Section 7, 8: Section 8

### 3 Set the quantization for Slicer.

You can choose from 4 settings:  $1/8$ ,  $1/4$ ,  $1/2$  and 1.

The quantization setting determines the length of the loop that plays while you hold the pad. For example, when quantization is set to 1, the entire section assigned to the pad plays in a loop, and when quantization is set to  $1/2$ , only the first half of the section assigned to the pad plays in a loop.

### 4 Press and hold down a Performance Pad.

While holding down the pad, playback continues in a loop.

- The length of the loop depends on the quantization setting.

When you release the pad, playback resumes from the position the track would have reached by that time.

When playback reaches the end of the domain (the section sliced into 8 equal sections) the playback position returns to the beginning of the domain.

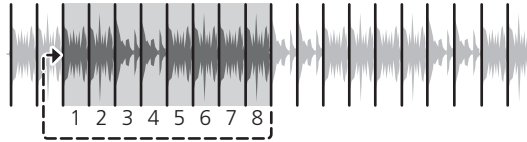

## ❖ Using Scratch Bank mode

You can load Scratch Bank sounds onto a deck so you can manipulate them with controls such as the jog wheel.

- 1 Open the **[SCRATCH BANK]** panel on Serato DJ Pro.
- 2 Press the **[SAMPLER]** mode button while holding the **[SHIFT]** button.  
The unit enters Scratch Bank mode.
- 3 Press a Performance Pad assigned with the Scratch Bank sound you want to load.  
The Scratch Bank sound is loaded onto the deck.
  - The Scratch Bank slots are assigned to the Performance Pads as follows:

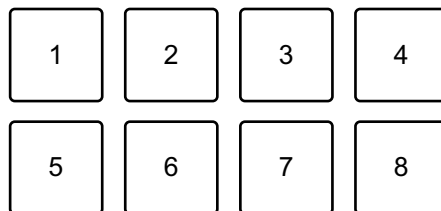

1: Slot 1, 2: Slot 2, 3: Slot 3, 4: Slot 4,  
5: Slot 5, 6: Slot 6, 7: Slot 7, 8: Slot 8

- 4 Press the Performance Pad while holding the **[SHIFT]** button.  
The previous loaded track is loaded again.



---

## Using Fader Start

### ❖ Using Channel Fader Start

- 1 Set the cue point.

Pause the track at the position you want to start playback from, then press the **[CUE]** button on that deck.

- 2 While holding the **[SHIFT]** button, move the channel fader from the bottom to the top.

Playback starts from the cue point.

- If you move the channel fader back to the bottom while holding the **[SHIFT]** button during playback, the track instantly jumps back to the cue point and playback pauses. (Back Cue)

When no cue point is set, playback starts from the beginning of the track.

### ❖ Using Crossfader Start

- 1 Set the cue point.

Pause the track at the position you want to start playback from, then press the **[CUE]** button on that deck.

- 2 Move the crossfader all the way to the left or right side.

If you want to use Crossfader Start to trigger playback on channel 2, set the crossfader to the left side, and vice versa.

(When you select **[Reverse]** on the Serato DJ Pro screen:

If you want to use Crossfader Start to trigger playback on channel 2, set the crossfader to the right side, and vice versa.)

- 3 While holding the **[SHIFT]** button, move the crossfader towards the opposite side from where it's set.

Playback starts from the cue point.

- If you move the crossfader back while holding the **[SHIFT]** button during playback, the playback position instantly jumps back to the cue point and pauses. (Back Cue)

When no cue point is set, playback starts from the beginning of the track.

---

## **Analyzing tracks**

Track analysis starts when you drag and drop a music file, or a folder containing music files, into the Track List in Serato DJ Pro.

- If a track is loaded to a deck before analysis is complete, it may take some time to display its BPM and waveform.
- Depending on the number of tracks, analysis may take some time.

## Using effects

The unit is equipped with 2 types of effects: FX1 and FX2.

### 1 Configure Multi FX mode in Serato DJ Pro.

Display the **[FX]** panel, and click Multi FX mode.

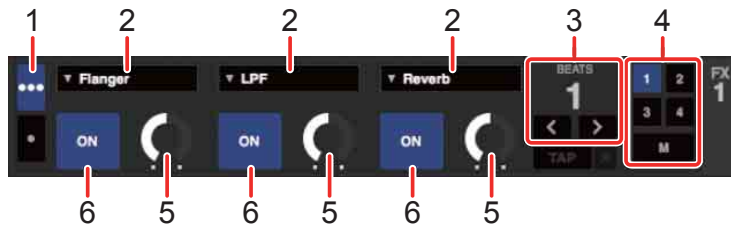

1: Multi FX mode selector, 2: Type of effect, 3: Beats of effect, 4: Channel for the effect, 5: Effect level, 6: Effect ON/OFF

### 2 Press the **[BEAT FX SELECT]** button on the unit.

The selected effect changes as follows each time you press the button:

FX1-1 → FX1-2 → FX1-3 → FX2-1 → FX2-2 → FX2-3 → FX1-1

If you press the **[BEAT FX SELECT]** button while holding the **[SHIFT]** button, the selected effect changes in the reverse order.

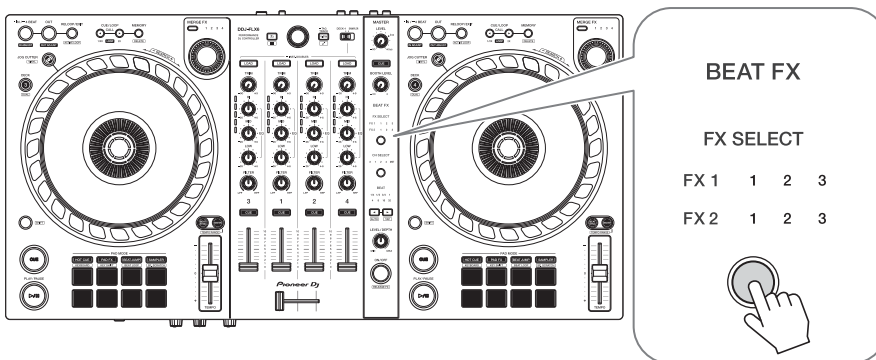

### 3 Press the **[BEAT FX CH SELECT]** button.

The channel that the selected effect will be applied to changes each time you press the button.

- **[1]**: Applies the effect to the sound of channel 1.
- **[2]**: Applies the effect to the sound of channel 2.

- **[3]**: Applies the effect to the sound of channel 3.
- **[4]**: Applies the effect to the sound of channel 4.
- **[MST]**: Applies the effect to the sound of the **[MASTER]** channel.

4 Press the **[BEAT ◀]** or **[BEAT ▶]** button.

Set the number of beats synchronized to the effect sound.

- If the number of beats is less than 1/4, 1/4 flashes.
- If the number of beats is 2, 1 and 4 light up.

5 Press the **[BEAT FX ON/OFF]** button.

The effect is applied to the sound from the channel you set in Step 3.

You can adjust the parameter of the effect by turning the **[BEAT FX LEVEL/DEPTH]** knob.

When the effect is on, the button flashes.

- Press the **[BEAT FX ON/OFF]** button again to turn off the effects.

## Using Merge FX

\* Before using Merge FX, be sure to activate FX Pack with the included license key.

You can use the **[MERGE FX]** knob to apply effects for mixing from the current track to the next.

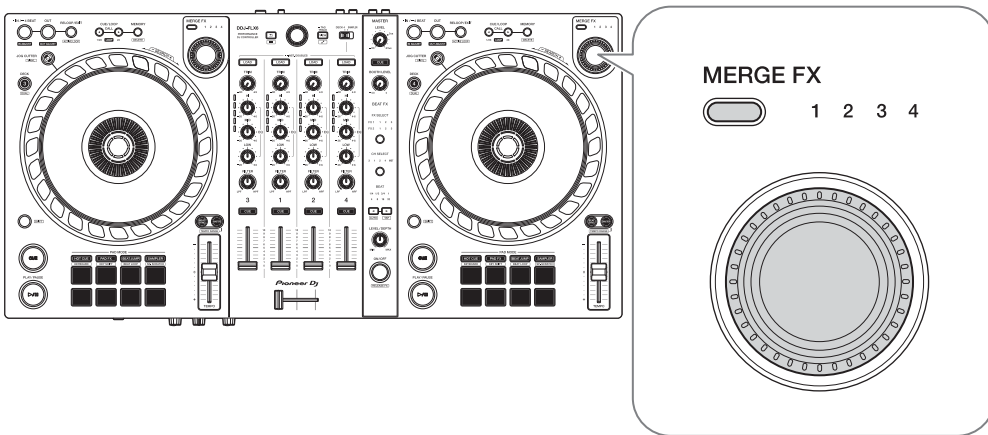

- 1 Press the **[MERGE FX]** select button.  
 The selected Merge FX type changes in order of Merge FX, 2, 3, 4 each time you press the button.  
 If you press the **[MERGE FX]** select button while holding the **[SHIFT]** button, the effect type changes in the reverse order.
- 2 Press the **[MERGE FX]** knob.  
 Merge FX turns on.  
 The effect is applied to the track that's currently playing.
  - Depending on the selected Merge FX type, the effect is applied as you turn the **[MERGE FX]** knob.
  - Settings for FX1 and FX2 are automatically changed.
- 3 Turn the **[MERGE FX]** knob.  
 The effect is applied to the track that's currently playing.  
 The effect sound changes the more you turn the knob.

- 4 Press the **[MERGE FX]** knob again.

The effect sound changes.

- 5 Turn Merge FX off.

You can turn Merge FX off in any of the following ways:

- Press the **[PLAY/PAUSE ►/||]** button.
- Press a Performance Pad while the unit is in Hot Cue mode.
- Press the **[MERGE FX]** select button.
- Press the **[CUE]** button during cue standby.
- Touch the jog wheel.

When Merge FX is turned off, settings for FX1 and FX2 return to their previous state.

---

## Recording

Serato DJ Pro has a recording feature that you can use to capture your performances. For detailed instructions on recording, see the Serato DJ Pro software manual.

- 1 Click **[REC]** in the upper area of the Serato DJ Pro screen.  
The **[REC]** panel is displayed.
- 2 Click **[REC]** in the **[REC]** panel to start recording.
  - If you click **[REC]** again, recording stops.
  - When recording is complete, the file is automatically saved.
  - You can't record sound from the **[MIC]** input terminal.

## Using a microphone

- 1 Connect a microphone to the **[MIC]** input terminal.
- 2 Turn the **[MIC LEVEL]** knob.  
Adjust the volume of the sound output from the **[MIC]** channel.
  - The sound comes out at a high volume if the knob is turned all the way to the right.
- 3 Input audio to the microphone.
  - You can't affect the microphone sound input to the unit.

---

## Using Jog Cutter

Turn on **[JOG CUTTER]** and move the jog wheel to create professional-sounding scratch effects (“scratch play”) with a section of a track (or a sample, when using Sample Scratch).

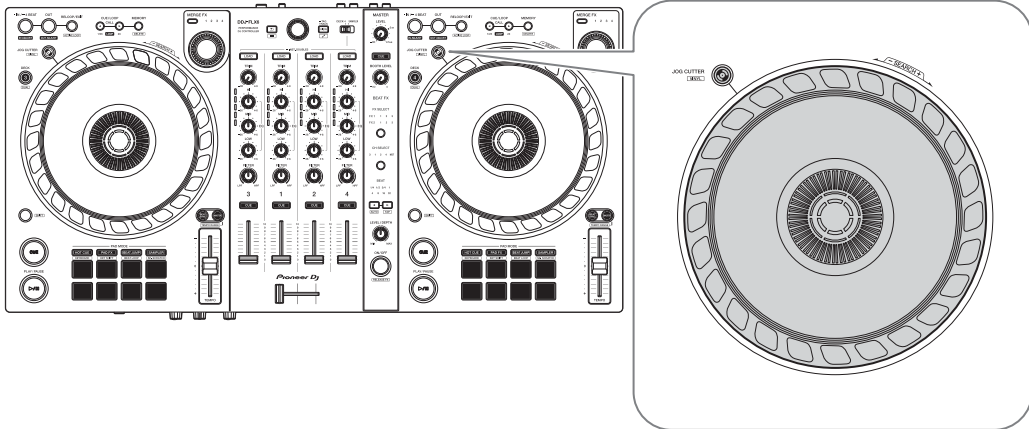

### 1 Set a Hot Cue.

In Hot Cue mode, press the Performance Pad to set a Hot Cue.

- If you’ve already set Hot Cues, call up the one you want to “scratch” with.
- When using Jog Cutter without setting Hot Cues, “scratch play” starts from the current playback position.

### 2 Press the **[JOG CUTTER]** button.

Jog Cutter mode turns on.

- If Vinyl mode isn’t turned on, turn it on before you press the **[JOG CUTTER]** button.
- Jog Cutter mode can’t be used on multiple decks at the same time. If you press one **[JOG CUTTER]** button and then the other, the button that is previously turned on will be turned off.

### 3 Hold the top of the jog wheel.

The playback position moves to the Hot Cue point, and “scratch play” starts.

- Set the Pad mode to the Hot Cue mode.
- Regardless the crossfader position, playback sound outputs from both decks.



## 4 Move the jog wheel to start “scratch play”.

When you move the jog wheel back and forth, you’ll hear a professional-sounding scratch effect applied to the sound.

- Different scratch effects are assigned to 6 areas of the jog wheel as follows. The type of “scratch play” changes as you change the scratch area by checking the indicator that appears when you touch the top of the jog wheel.

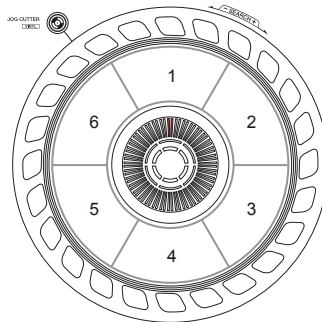

## 5 Release your hand from the top of the jog wheel.

“Scratch play” stops and the track continues to play as normal from the Hot Cue/playback position.

## 6 Press the [**JOG CUTTER**] button again.

Jog Cutter mode turns off.

## Playing Sampler sound on channel 4

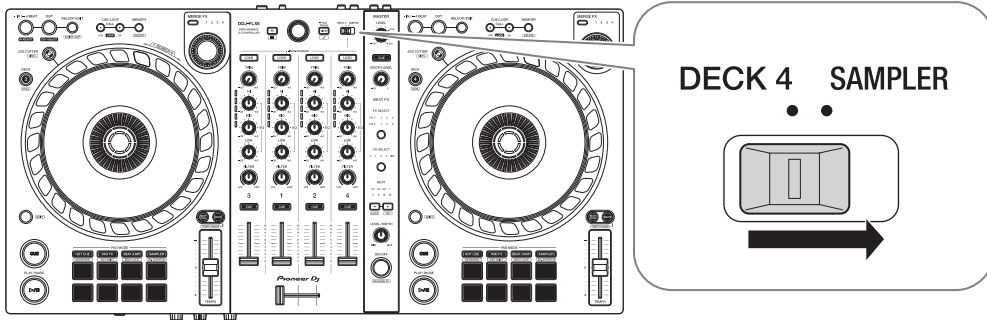

Set the **[DECK4/SAMPLER]** selector switch to **[SAMPLER]**.

The input to channel 4 changes to the sampler sound.

- Sound from deck 4 can't be output from channel 4 while the **[DECK4/SAMPLER]** selector switch is set to **[SAMPLER]**.

---

## Changing the crossfader assign

You can select **[Reverse]** or **[Disable]** on the Serato DJ Pro screen.

- 1 Click  in Serato DJ Pro.
- 2 Click the **[Mixer]** tab.
  - **[Reverse]**: Reverses the crossfader assign.
  - **[Disable]**: Deactivates the crossfader and allows sound from any channel to pass through.

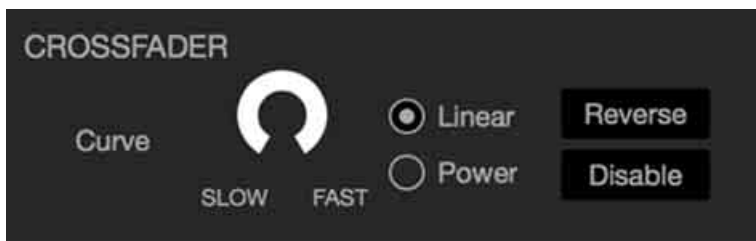

---

## Setting the crossfader curve

You can set the crossfader curve on the Serato DJ Pro screen.

- 1 Click  in Serato DJ Pro.
- 2 Click the **[Mixer]** tab.
- 3 Adjust the crossfader curve.
  - The more you turn it toward **[SLOW]**, the more the curve gradually rises.
  - The more you turn it toward **[FAST]**, the more the curve sharply rises.

---

---

# Changing the settings

---

---

## Launching Utilities mode

Be sure to close your DJ application and then launch Utilities mode.

To use Utilities mode with connecting to rekordbox, set on the preferences screen on rekordbox. Refer to page 68 to change the settings on rekordbox.

(To use MIDI controller mode and Demo mode, set them on the unit.)

- 1 Disconnect the USB cable from your PC/Mac.
- 2 Hold both the **[SHIFT]** and **[PLAY/PAUSE ►/III]** buttons on the left deck and connect the USB cable to your PC/Mac.  
Utilities mode launches.
- 3 Change the settings.  
When you change the settings, they will be saved. While saving, the bottom row of Performance Pads on the left deck flashes. If you disconnect the USB cable while the pads are flashing, settings may not be saved.
- 4 Disconnect the USB cable to turn off the unit.  
Utilities mode turns off.

## Utilities mode settings

You can change the following settings in Utilities mode:

- MIDI controller mode
- Back Spin Length
- Fader Start
- Crossfader Cut Lag
- Microphone sound through the Booth output
- Demo mode

### ❖ MIDI controller mode

The unit works in different ways according to whether rekordbox or Serato DJ Pro is running.

- When rekordbox is running, you can use the unit to control selected rekordbox features.
- When Serato DJ Pro is running, you can use the unit to control selected Serato DJ Pro features.
- When neither rekordbox or Serato DJ Pro is running, you can use the unit as a general MIDI controller.

Press the **[BEAT JUMP]** mode button on the left deck.

- **[BEAT JUMP]** mode button isn't lit: The unit's operation automatically changes according to whether rekordbox or Serato DJ Pro is running. (Default)
- **[BEAT JUMP]** mode button is lit: Even though rekordbox or Serato DJ Pro is running, the unit is set for use as a general MIDI controller.

## ❖ Back Spin Length

When using a jog wheel to perform a Back Spin, you can make the Back Spin longer or shorter than the amount you rotate the jog wheel by.

You can set the Back Spin Length to short, normal, or long.

Press one of the Performance Pads 1 through 3 on the right deck.

- Pad 1 is lit: Back Spin Length short
- Pad 2 is lit: Back Spin Length normal (Default)
- Pad 3 is lit: Back Spin Length long

## ❖ Fader Start

Press the **[HOT CUE]** mode button on the left deck.

- **[HOT CUE]** mode button is lit: Fader Start is turned on. (Default)
- **[HOT CUE]** mode button is not lit: Fader Start is turned off.

## ❖ Crossfader Cut Lag

You can adjust the cut lag (the range where no sound is heard from the relevant deck) at both edges of the crossfader.

You can make adjustments in increments of 0.1 mm within a range of 0.3 mm to 5.5 mm. (Setting value: 1 through 53)

- The setting amount for the Cut Lag is a guide, and may not be exact.
- The default Cut Lag amount is 1.0 mm. (Setting value: 8)

Turn the rotary selector.

The number of lights that are lit up on the channel level indicators indicates the setting value (1 through 53).

- The number of lights that are lit up on the channel level indicators on channel 1: tens place.
- The sum of the number of lights that are lit up on the channel level indicators on channel 2 and 4: ones place.

# Changing the settings

E.g. 2 lights on channel 1, plus 3 lights on channel 2, plus 5 lights on channel 4 means the total value is 28 ( $20 + 3 + 5 = 28$ ).

## ❖ **Microphone sound through the Booth output**

Change whether or not the microphone sound comes out of the booth channel.

Press the **[PAD FX]** mode button on the left deck.

- **[PAD FX]** mode button is lit: The microphone sound comes out of the booth channel. (Default)
- **[PAD FX]** mode button is not lit: The microphone sound doesn't come out of the booth channel.

## ❖ **Demo mode**

In normal conditions, if you don't use any features for a specified amount of time, the unit will enter Demo mode.

- When any knob or button on the unit is used during Demo mode, Demo mode is canceled.

Press one of the Performance Pads 1 through 4 on the left deck.

- Pad 1 is lit: Demo mode is switched off.
- Pad 2 is lit: Demo mode starts when you don't use the unit for 1 minute.
- Pad 3 is lit: Demo mode starts when you don't use the unit for 5 minutes.
- Pad 4 is lit: Demo mode starts when you don't use the unit for 10 minutes. (Default)

---

---

# Additional information

---

---

## Troubleshooting

If you think something is wrong with the unit, check the information below and refer to the **[FAQ]** for the DDJ-FLX6 on the Pioneer DJ website.

[pioneerdj.com/support/](http://pioneerdj.com/support/)

Sometimes, the problem may be caused by another device. Inspect the other devices and electrical appliances you're using and refer to their manuals and FAQ if necessary. If the problems continue, read the Precautions for Use and consult an authorized service company or your dealer.

- The unit may not work properly if it's subjected to static electricity or other external influences. In this case, turn the unit off and on again to restore proper operation.

---

---

## Power

- ❖ **The unit does not power up.**
  - See: Connections (page 27)



## Connection

### ❖ The unit isn't recognized by your PC/Mac.

- Connect the supplied USB cable correctly. See: Connections (page 27)
- If you're using a USB hub, disconnect it.
- Quit any other open applications including screen savers and antivirus security software on your PC/Mac. (When quitting antivirus security software, before doing so, disable the internet connection to ensure the security of your PC/Mac.)
- If another USB device is connected to your PC/Mac, disconnect it.
- If your PC/Mac has multiple USB Type A ports, try connecting to another one.
- For Mac, launch the macOS utility software **[Audio MIDI Setup]**, and check that the **[Windows]** on the menu bar > **[Show Audio Devices]** > **[DDJ-FLX6 Audio Out]** is displayed.
- For Mac, the sound setting may not be correct. Disconnect the USB cable, launch the the macOS utility software **[Audio MIDI Setup]**, and display **[MIDI Window]** or **[MIDI Studio]**. Select the **[DDJ-FLX6]** icon, and click **[Remove Device]**. (The icon may be **[USB MIDI Device]** instead of **[DDJ-FLX6]**. In this case, select **[USB MIDI Device]**.) Connect the unit with the USB cable again. The **[DDJ-FLX6]** icon is displayed.
- For Windows, check that **[DDJ-FLX6]** is displayed under **[Device Manager]** > **[Sound, video and game controllers]**.

## Sound

### ❖ **Sound isn't output, is too quiet, or is distorted.**

- Set the **[TRIM]** knob, channel fader, crossfader, and **[MASTER LEVEL]** knob to the correct positions. See: Playing a track (page 37) (page 79)
- Connect the connection cable properly. See: Connections (page 27)
- Clean the terminals and plugs before connecting the cable to the unit.
- If sound is distorted, change the buffer size for your DJ software.

### ❖ **Microphone sound can't be output.**

- Set the **[MIC ATT.]** knob and **[MIC LEVEL]** knob to the correct positions. See: Rear panel (page 25) Front panel (page 26)

### ❖ **Headphones sound is too quiet.**

- When the power supply from the USB port is insufficient, the unit limits the volume of headphones. Disconnect devices you're not using for DJing to direct more power to the unit.

## rekordbox

### ❖ rekordbox becomes unstable.

- Update rekordbox to the latest version. See: Installing rekordbox (page 31)
- Quit any other applications on your PC/Mac. If rekordbox remains unstable, try disabling the wireless network or other wireless connections, antivirus software, screen saver, low-power mode, etc.
- If another USB device is connected to your PC/Mac, disconnect it.
- If you're using a USB hub, disconnect it.
- If you're using battery power for your laptop, connect the laptop to an AC power supply.

### ❖ rekordbox can't be controlled by the unit./The platter isn't displayed on the deck./Settings described in this manual aren't displayed.

- Click **[EXPORT]** at the top-left corner of the rekordbox screen to switch to **[PERFORMANCE]** mode.

### ❖ BPM and beatgrid are not displayed correctly./Beatgrid is misaligned.

- Change the BPM analysis range and analyze the track again. If it doesn't work, manually set the beatgrid and BPM.
- Adjust the beatgrid. For details on how to adjust the beatgrid, see the rekordbox Instruction Manual.

### ❖ Sound is interrupted while using DJ software.

- Set the buffer size in **[Preferences]** > **[Audio]** in rekordbox.

### ❖ **Fader Start doesn't work.**

- Set a cue.
- To activate Fader Start, mark the **[Fader Start]** check box in **[Preferences] > [Controller] > [Mixer]** tab in rekordbox.

### ❖ **Jog Cutter doesn't work.**

- To use Jog Cutter, turn Vinyl mode on. See: Using Jog Cutter (page 65)

### ❖ **When the unit is disconnected, recording isn't available in rekordbox.**

- If you don't have one of the relevant subscription plans, you can't record without connecting to the unit. Connect the unit or another Hardware Unlock device, or take out one of the relevant subscription plans to enable recording.

### ❖ **Sound doesn't output from deck 4.**

- Set the **[DECK4/SAMPLER]** selector switch to **[DECK4]**.

## Serato DJ Pro

### ❖ Serato DJ Pro becomes unstable.

- Update Serato DJ Pro to the latest version. See: Installing Serato DJ Pro (page 70)
- Quit any other applications on your PC/Mac. If Serato DJ Pro remains unstable, try disabling the wireless network or other wireless connections, antivirus software, screen saver, low-power mode, etc.
- If another USB device is connected to your PC/Mac, disconnect it.
- If you're using a USB hub, disconnect it.
- If you're using battery power for your laptop, connect the laptop to an AC power supply.

### ❖ Tracks aren't displayed in the library.

- Import music files. For details about importing music files, see the Serato DJ Pro software manual.
- If you selected a crate or subcrate which doesn't contain any tracks, select another crate or subcrate which does contain tracks, or import tracks into the crate or subcrate.

### ❖ iTunes tracks aren't displayed in the library.

- Activate **[Show iTunes Library]** in the **[Library + Display]** tab of the **[SETUP]** menu. If **[Show iTunes Library]** is already selected, deactivate it, then activate it again. For details about importing music files, see the Serato DJ Pro software manual.
- If you selected a crate or subcrate which doesn't contain any tracks, select another crate or subcrate which does contain tracks, or import tracks into the crate or subcrate.

### ❖ **Music files in the library can't be edited.**

- Deactivate **[Protect Library]** in the **[Library + Display]** tab of the **[SETUP]** menu.

### ❖ **Serato DJ Pro virtual deck isn't displayed. (Offline player is displayed.)**

- Connect the supplied USB cable correctly. See: Connections (page 27)
- Update Serato DJ Pro to the latest version. See: Installing Serato DJ Pro (page 70)

### ❖ **Fader Start doesn't work.**

- Set a cue.
- Use the Utilities mode to activate Fader Start. See: Fader Start (page 106)

### ❖ **BPM isn't displayed./SYNC and Auto Loop don't work.**

- Mark the **[Set Auto BPM]** check box in the offline player setting, then analyze the track. For details on how to analyze a track, see the Serato DJ Pro software manual.

### ❖ **BPM and beatgrid are not displayed correctly./Beatgrid is misaligned.**

- Change the BPM analysis range and analyze the track again. If it still doesn't work, manually set the beatgrid and BPM.
- Adjust the beatgrid. For details on how to adjust the beatgrid, see the Serato DJ Pro software manual.
- During playback, hold the **[SHIFT]** button and tap the headphone **[CUE]** button (channel) to set the tempo of the respective deck in time with your tapping (Tapping function). You can adjust the BPM or beatgrid of the track.

## Additional information

When using the Tapping function, **[Beat Grid Editor]** is displayed on the deck section on your PC/Mac screen. To return the display of the deck, click **[Edit Grid]** on your PC/Mac screen.

- ❖ **BPM is displayed, but the beatgrid isn't displayed./The Slicer function doesn't work./Skip mode doesn't work.**
  - Mark the **[Set Auto BPM]** and **[Set Beat Grid / BPM]** check boxes in the offline player setting, then analyze the track. For details on how to analyze a track, see the Serato DJ Pro software manual.
  - Set the beatgrid. For details on how to set the beatgrid, see the Serato DJ Pro software manual.
  
- ❖ **Jog Cutter doesn't work.**
  - To use Jog Cutter, turn Vinyl mode on. See: Using Jog Cutter (page 100)
  
- ❖ **Sound from deck 4 doesn't output.**
  - Set the **[DECK4/SAMPLER]** selector switch to **[DECK4]**.
  
- ❖ **Merge FX doesn't work.**
  - Activate your FX Pack license.

---

### Others

- ❖ **The indicator flashes and the unit doesn't seem to be working properly.**
  - If the unit behaves unusually or doesn't turn on, disconnect the USB cable, wait a while, then reconnect the USB cable to turn on the unit.

---



---

## Specifications

### General – Main Unit

Power supply .....	DC 5 V
Rated current.....	500 mA
Main unit weight.....	3.8 kg (8.4 lbs.)
Max. dimensions (W × D × H) .....	676.0 × 345.7 × 68.7 mm (26.6" × 13.6" × 2.7")
Tolerable operating temperature.....	+5 °C – +35 °C (+41 °F – +95 °F)
Tolerable operating humidity.....	5 % – 85 % (no condensation)

### Audio Section

Sampling rate .....	44.1 kHz
A/D, D/A converters .....	24bit
Frequency characteristic <b>USB, MIC</b> .....	20 Hz – 20 kHz
S/N ratio (rated output, A-WEIGHTED) <b>USB</b> .....	104 dB
Total harmonic distortion (20 Hz to 20 kHz BW) <b>USB</b> .....	0.004 %
Input impedance <b>MIC</b> .....	3 kΩ
Output impedance <b>MASTER, BOOTH</b> .....	1 kΩ or less
<b>PHONES</b> .....	10 Ω or less
Rated output level / Load impedance <b>MASTER, BOOTH</b> .....	2.1 Vrms/10 kΩ

### Input / Output terminals

<b>MIC</b> input terminal 1/4" TRS jack.....	1 set
<b>MASTER</b> output terminal RCA pin jacks .....	1 set



## Additional information

### **BOOTH** output terminal

RCA pin jacks ..... 1 set

### **PHONES** output terminals

1/4" stereo jack ..... 1 set

3.5 mm stereo mini jack..... 1 set

### **USB** port

USB (Type B)..... 1 set

- For improvement purposes, specifications and design of this unit are subject to change without notice.

### **Using the unit as a controller for other DJ applications**

The unit also outputs operating data for the buttons and knobs in MIDI format. If you connect a PC/Mac with a built-in MIDI-compatible DJ application via the USB cable, you can control the DJ application with the unit. (You need to set MIDI details in the DJ application.)

- For details, see your DJ application's user guide.

---

### **About MIDI messages**

For details on this unit's MIDI messages, see the List of MIDI Messages.

- You can find the List of MIDI Messages on the Pioneer DJ website: [pioneerdj.com/](http://pioneerdj.com/)

## Trademarks and registered trademarks

- rekordbox™ is a trademark or registered trademark of AlphaTheta Corporation.
- Mac, macOS and Finder are trademarks of Apple Inc., registered in the U.S. and other countries.
- Windows is a registered trademark of Microsoft Corporation in the United States and other countries.
- Serato DJ Pro, Scratch Live, ITCH and Serato DJ Intro are registered trademarks of Serato Limited.

Other product, technology and company names, etc. mentioned herein are trademarks or registered trademarks of their respective owners.

### About using MP3 files

This product has been licensed for nonprofit use. This product has not been licensed for commercial purposes (for profit-making use), such as broadcasting (terrestrial, satellite, cable or other types of broadcasting), streaming on the Internet, Intranet (a corporate network) or other types of networks or distributing of electronic information (online digital music distribution service). You need to acquire the corresponding licenses for such uses. For details, refer to <http://www.mp3licensing.com>.

## Software license notice

### Apache

Copyright (c) 2009-2019 ARM Limited. All rights reserved.

SPDX-License-Identifier: Apache-2.0

Licensed under the Apache License, Version 2.0 (the License); you may not use this file except in compliance with the License. You may obtain a copy of the License at

[www.apache.org/licenses/LICENSE-2.0](http://www.apache.org/licenses/LICENSE-2.0)

Unless required by applicable law or agreed to in writing, software distributed under the License is distributed on an AS IS BASIS, WITHOUT WARRANTIES OR CONDITIONS OF ANY KIND, either express or implied.

See the License for the specific language governing permissions and limitations under the License.

### BSD

The BSD-3-Clause License

Copyright (c) 2015, Freescale Semiconductor, Inc.

Copyright 2016-2020 NXP

All rights reserved.

Redistribution and use in source and binary forms, with or without modification, are permitted provided that the following conditions are met:

1. Redistributions of source code must retain the above copyright notice, this list of conditions and the following disclaimer.

## Additional information

2. Redistributions in binary form must reproduce the above copyright notice, this list of conditions and the following disclaimer in the documentation and/or other materials provided with the distribution.
3. Neither the name of the copyright holder nor the names of its contributors may be used to endorse or promote products derived from this software without specific prior written permission.

THIS SOFTWARE IS PROVIDED BY THE COPYRIGHT HOLDERS AND CONTRIBUTORS "AS IS" AND ANY EXPRESS OR IMPLIED WARRANTIES, INCLUDING, BUT NOT LIMITED TO, THE IMPLIED WARRANTIES OF MERCHANTABILITY AND FITNESS FOR A PARTICULAR PURPOSE ARE DISCLAIMED. IN NO EVENT SHALL THE COPYRIGHT HOLDER OR CONTRIBUTORS BE LIABLE FOR ANY DIRECT, INDIRECT, INCIDENTAL, SPECIAL, EXEMPLARY, OR CONSEQUENTIAL DAMAGES (INCLUDING, BUT NOT LIMITED TO, PROCUREMENT OF SUBSTITUTE GOODS OR SERVICES; LOSS OF USE, DATA, OR PROFITS; OR BUSINESS INTERRUPTION) HOWEVER CAUSED AND ON ANY THEORY OF LIABILITY, WHETHER IN CONTRACT, STRICT LIABILITY, OR TORT (INCLUDING NEGLIGENCE OR OTHERWISE) ARISING IN ANY WAY OUT OF THE USE OF THIS SOFTWARE, EVEN IF ADVISED OF THE POSSIBILITY OF SUCH DAMAGE.

## Cautions on copyrights

rekordbox restricts playback and duplication of copyright-protected music contents.

- When coded data, etc., for protecting the copyright is embedded in the music contents, it may not be possible to operate the program normally.
- When rekordbox detects that coded data, etc., for protecting the copyright is embedded in the music contents, processing (playback, reading, etc.) may stop.

Recordings you have made are for your personal enjoyment and according to copyright laws may not be used without the consent of the copyright holder.

- Music recorded from CDs, etc., is protected by the copyright laws of individual countries and by international treaties. It is the full responsibility of the person who has recorded the music to ensure that it is used legally.
- When handling music downloaded from the Internet, etc., it is the full responsibility of the person who has downloaded the music to ensure that it is used in accordance with the contract concluded with the download site.

The specifications and design of this product are subject to change without notice.

© 2020 AlphaTheta Corporation

All rights reserved.

<DRI1673-B>